

NO.	COMPONENTS	IMPEDANCE
1	TNC REVERSE POLARITY FEMALE	50 OHM
2	RG223	50 OHM
3	HEAT SHRINKING TUBE	

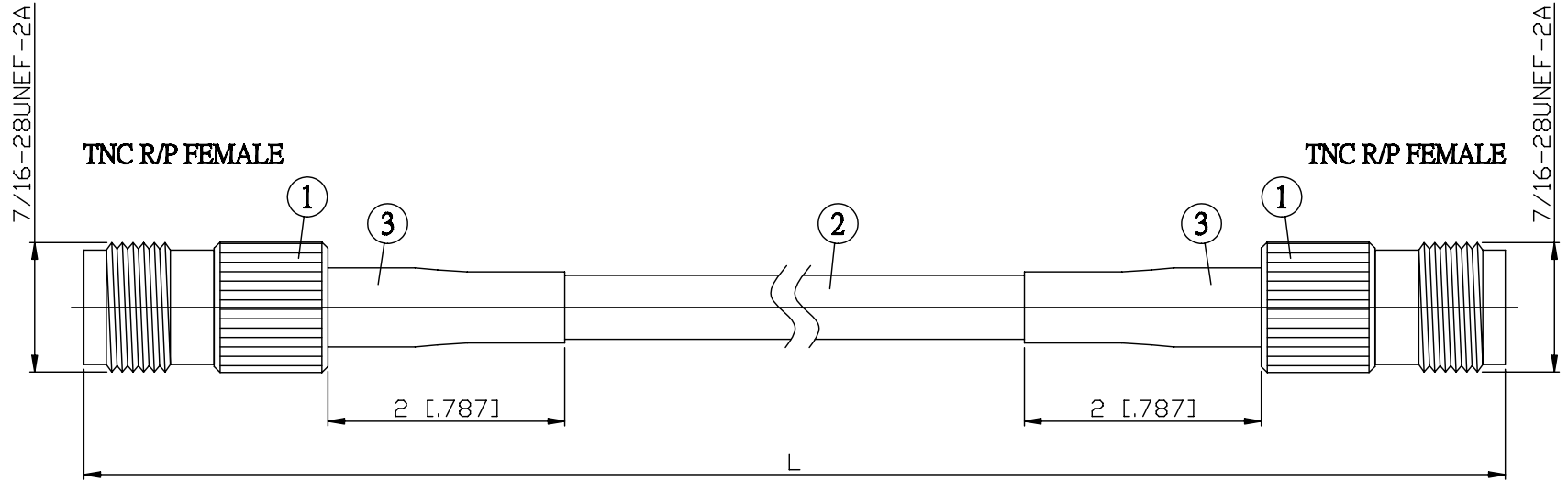

JYE BAO P/N	L CM (INCH)
T90T90-223-15	15 (5.906)
T90T90-223-30	30 (11.811)
T90T90-223-50	50 (19.685)
T90T90-223-100	100 (39.370)
T90T90-223-150	150 (59.055)
T90T90-223-200	200 (78.740)
T90T90-223-XXX	CUSTOM LENGTH IN CM

LENGTH TOLERANCE IS $\pm 1.5\%$ OR $\pm 10\text{MM}$, WHICHEVER IS GREATER.	JYE BAO CO., LTD. TAIPEI TAIWAN
	DESCRIPTION CABLE ASSEMBLY TNC R/P JACK TO TNC R/P JACK
	JYE BAO DRAWING NO. T90T90-223-XXX