

NO.	COMPONENTS	IMPEDANCE
1	TNC FEMALE	75 OHM
2	RG179	75 OHM
3	HEAT SHRINKING TUBE	

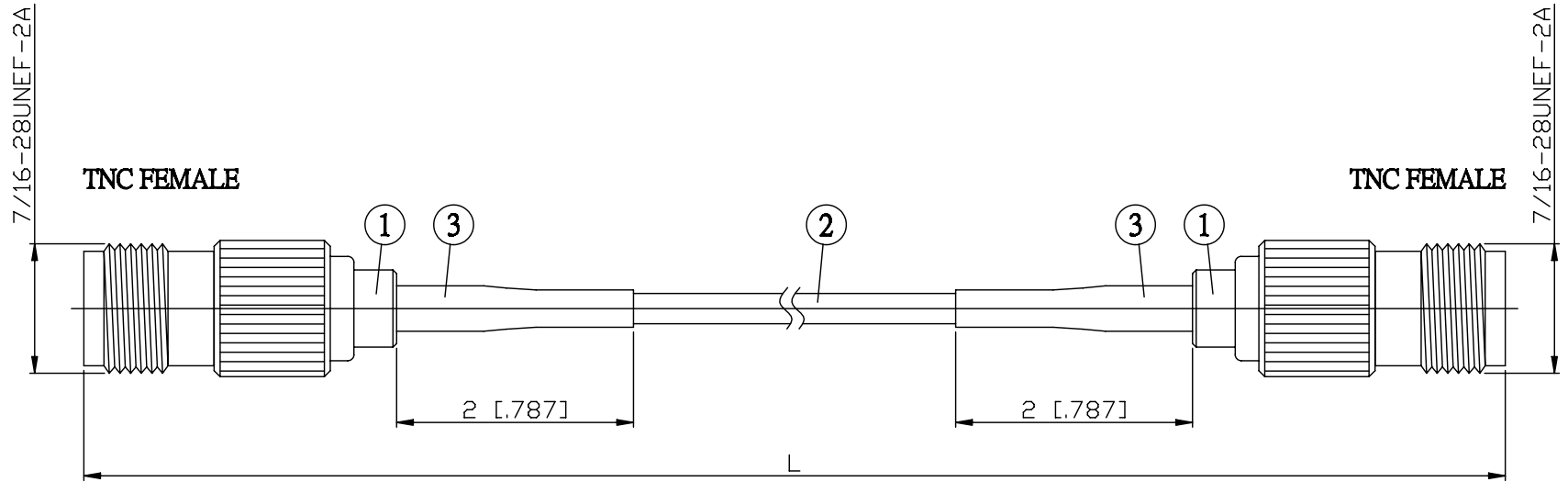

JYE BAO P/N	L CM (INCH)
T80T80-179-15	15 (5.906)
T80T80-179-30	30 (11.811)
T80T80-179-50	50 (19.685)
T80T80-179-100	100 (39.370)
T80T80-179-150	150 (59.055)
T80T80-179-200	200 (78.740)
T80T80-179-XXX	CUSTOM LENGTH IN CM

LENGTH TOLERANCE IS $\pm 1.5\%$ OR $\pm 10\text{MM}$, WHICHEVER IS GREATER.	JYE BAO CO., LTD. TAIPEI TAIWAN
	DESCRIPTION CABLE ASSEMBLY TNC JACK TO TNC JACK
	JYE BAO DRAWING NO. T80T80-179-XXX