

NO.	COMPONENTS	IMPEDANCE
1	TNC REVERSE POLARITY MALE	50 OHM
2	RG174	50 OHM
3	HEAT SHRINKING TUBE	
4	TNC REVERSE POLARITY FEMALE	50 OHM

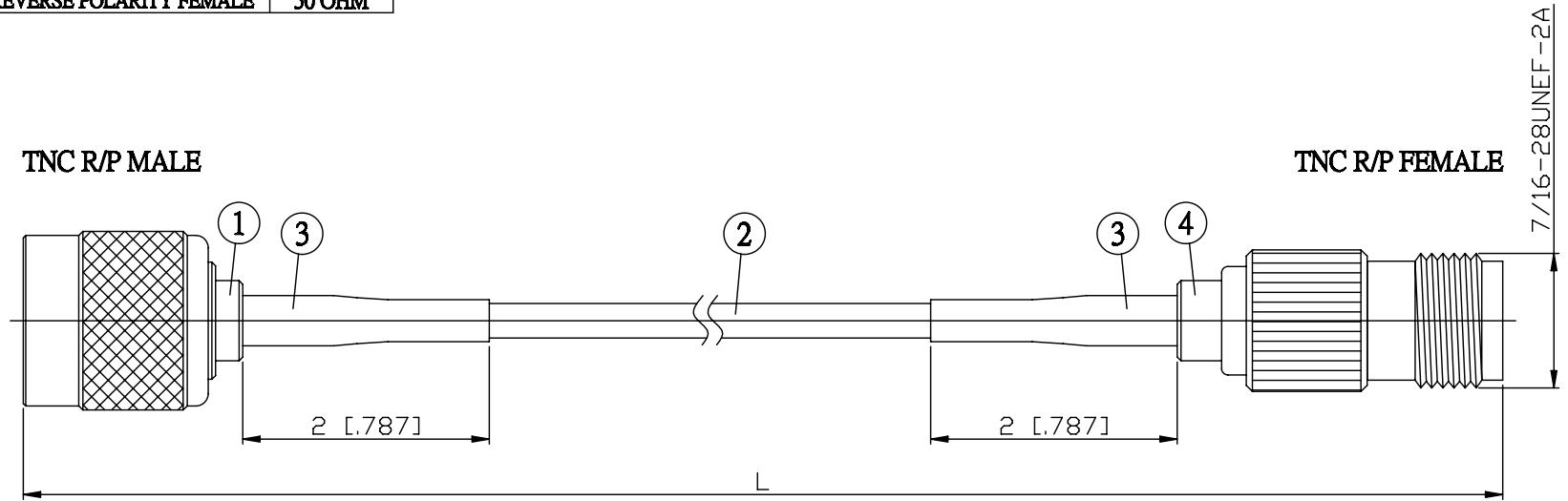

JYE BAO P/N	L CM (INCH)
T60T90-174-15	15 (5.906)
T60T90-174-30	30 (11.811)
T60T90-174-50	50 (19.685)
T60T90-174-100	100 (39.370)
T60T90-174-150	150 (59.055)
T60T90-174-200	200 (78.740)
T60T90-174-XXX	CUSTOM LENGTH IN CM

LENGTH TOLERANCE IS $\pm 1.5\%$ OR $\pm 10\text{MM}$, WHICHEVER IS GREATER.	JYE BAO CO., LTD. TAIPEI TAIWAN
	DESCRIPTION CABLE ASSEMBLY TNC R/P PLUG TO TNC R/P JACK
	JYE BAO DRAWING NO. T60T90-174-XXX