

SMA8F46C-0018

SMA Field Replaceable Jack,
Square ϕ 12.7mm (.500inch) 4 Hole Flange With EMI Gasket, 50 Ω
Accepts ϕ 0.46mm (.018inch) pin, 27GHz VSWR 1.2

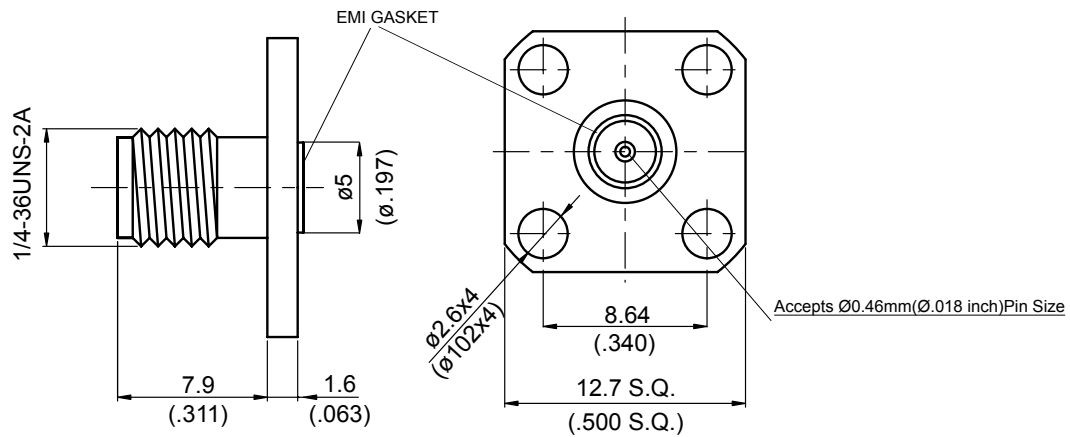

Parts	Material	Plating (Micro-inch)
EMI Gasket	Conductive Silicon Elastomers	
Contact Pin	Beryllium Copper	Gold 4 Over Nickel-Phosphorus Alloy 80 Over Copper 20
Insulator	Teflon	
Body	Stainless	Passivated

Weight: 2.4 g

This part number complies with RoHS.

Notice: JYEBAO reserves the right to make modifications deemed appropriate.

SMA	SMA8F46C-0018
<div data-bbox="167 347 568 392" style="border: 1px solid black; padding: 2px;">Interface</div> <p>MIL-STD-348B Mechanically compatible with 2.92 & 3.5</p>	
<div data-bbox="167 510 568 555" style="border: 1px solid black; padding: 2px;">Electrical Data</div> <p>Impedance 50Ω Frequency range DC to 27GHz VSWR ≤ 1.2 (DC to 27GHz) Insertion loss $\leq 0.04 \times \sqrt{f(\text{GHz})}$ dB Insulation resistance $\geq 5000\text{M}\Omega$ Contact resistance inner conductor $\leq 3\text{m}\Omega$ Contact resistance outer conductor $\leq 2\text{m}\Omega$ Dielectric withstanding voltage (at sea level) 1500 V rms Working voltage (at sea level) 500 V rms</p>	
<div data-bbox="167 1057 568 1102" style="border: 1px solid black; padding: 2px;">Mechanical Data</div> <p>Recommended coupling nut torque 7 to 9.5 inch lbs Coupling proof torque 15 inch lbs Coupling nut retention force ≥ 60.7 lbs Contact Captivation-axial ≥ 6.1 lbs Durability (mating) ≥ 500</p>	
<div data-bbox="167 1411 568 1456" style="border: 1px solid black; padding: 2px;">Environmental Data</div> <p>Temperature range -40°C to +125°C Thermal shock MIL-STD-202, Method 107, Condition B Moisture resistance MIL-STD-202, Method 106 Corrosion MIL-STD-202, Method 101, Condition B RoHS Compliant</p>	
<div data-bbox="167 1765 568 1809" style="border: 1px solid black; padding: 2px;">Tooling</div>	

Notice: JYEBAO reserves the right to make modifications deemed appropriate.