

SMA3F26M6-0020

**2-Hole Flange Field Receptacle Plug
(Special Thread)**

50Ω

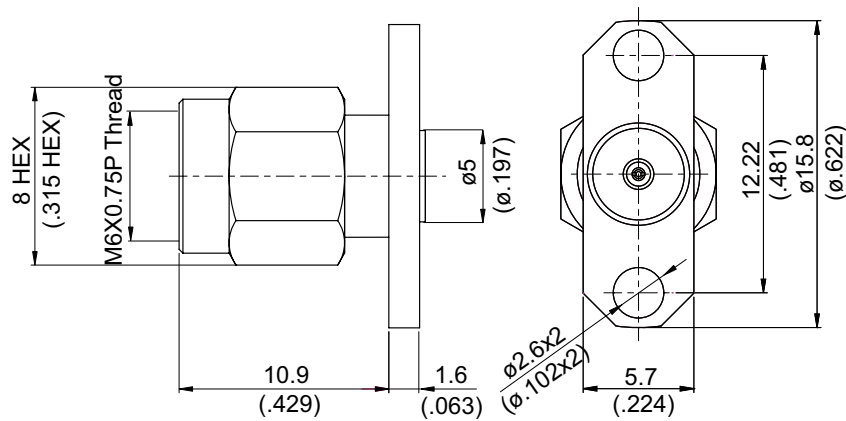

NOTE: M6 X 0.75 P THREAD ; RETURN LOSS ≤ -20dB UP TO 27 GHz

Parts	Material	Plating (Micro-inch)
EMI Gasket	Conductive Silicon Elastomers	
Renber Ring	Beryllium Copper	Tin-Zinc-Copper-Alloy 100 Over Copper 50
Gasket	Silicon	
Contact Pin	Beryllium Copper	Gold 20 Over Nickel 50 Over Copper 50
Insulator	Teflon	
Body	Stainless	Passivated
Coupling Nut	Stainless	Passivated

Weight:

This part number complies with RoHS.

Notice: JYEBAO reserves the right to make modifications deemed appropriate.