

S-N-F-50-4G

N Jack 50ohm Short
4GHz 0.1dB

50Ω

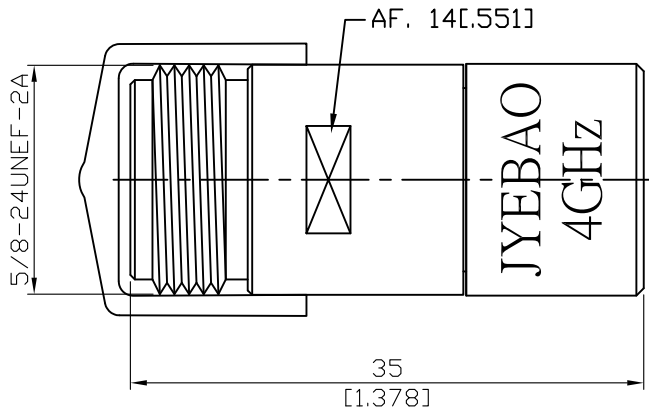

SHORT				
Frequency Range	DC-4GHz			
Impedance	50Ω			
Offset length	Agilent	Anritsu	Rohde&Schwarz	
	42.70ps	12.81mm	12.81mm	
Inductance	Agilent/Anritsu		Rohde&Schwarz	
	L0	(1E-12) H	0.000 pH	0.0000000
L1	(1E-24) H/Hz	0.000	pH/GHz	0.0000000
L2	(1E-33) H/Hz ²	0.000	pH/GHz ²	0.0000000
L3	(1E-42) H/Hz ³	0.000	pH/GHz ³	0.0000000
Phase Error				
DC-4GHz	≤1.5°			
Return Loss				
DC-4GHz	≤0.10dB			

Notes:

1. Temperature range for optimal results: +20 °C to +26 °C
2. Storage temperature range: -20 °C to +75°C
3. When not in use put on cap to keep connector clean
4. Return loss test results shipped along with goods
5. Use with Jyebao open O-N-F-50-4G

Parts	Material	Plating (Micro-inch)
Cover	Aluminium	Anodized(Green)
Contact Pin	Beryllium Copper	Gold 4 Over Nickel-Phosphorus Alloy 80 Over Copper 20
Body	Brass	Tin-Zinc-Copper-Alloy 100 Over Copper 50
Cap	PVC	

This part number complies with RoHS.

Notice: JYEBAO reserves the right to make modifications deemed appropriate.

S-N-F-50-4G

SHORT return loss & phase error

