

OSLT-SMA-M-18G

SMA Plug 50ohm Open Short Load Through 18GHz

50Ω

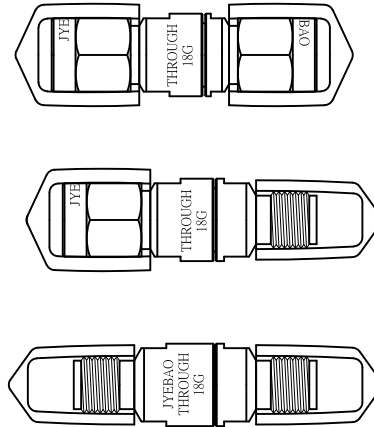
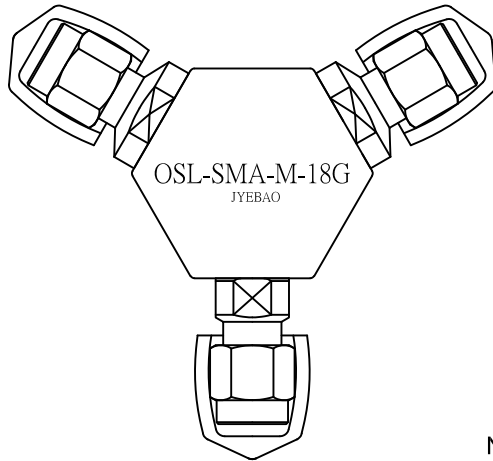

Notes:

1. Temperature range for optimal results: +20 °C to +26 °C
2. Storage temperature range: -20 °C to +75°C
3. When not in use put on cap to keep connector clean
4. Return loss test results shipped along with goods

OPEN				SHORT					
Frequency Range	DC-18GHz			Frequency Range	DC-18GHz				
Impedance	50Ω			Impedance	50Ω				
Offset length	Agilent	Anritsu	Rohde&Schwarz	Offset length	Agilent	Anritsu	Rohde&Schwarz		
	16.70ps	5.01mm	5.01mm		16.70ps	5.01mm	5.01mm		
Capacitance	Agilent/Anritsu		Rohde&Schwarz	Inductance	Agilent/Anritsu		Rohde&Schwarz		
	C0	(1E-15) F	4.500		fF	4.5000000	L0	(1E-12) H	4.000
C1	(1E-27) F/Hz	395.000	fF/GHz	0.3950000	L1	(1E-24) H/Hz	-650.000	pH/GHz	-0.6500000
C2	(1E-36) F/Hz ²	-20.000	fF/GHz ²	-0.0200000	L2	(1E-33) H/Hz ²	39.000	pH/GHz ²	0.0390000
C3	(1E-45) F/Hz ³	0.400	fF/GHz ³	0.0004000	L3	(1E-42) H/Hz ³	-0.640	pH/GHz ³	-0.0006400
Phase Error	DC-6GHz			≤1°	Phase Error	DC-6GHz			≤1°
	6-18Ghz			≤3°		6-18Ghz			≤3°
Return Loss	DC-6GHz			≤0.10dB	Return Loss	DC-6GHz			≤0.10dB
	6-18GHz			≤0.20dB		6-18GHz			≤0.20dB

Load		Through Adaptor			
Frequency Range	DC-18GHz	Frequency Range	DC-18GHz		
Impedance	50Ω	Impedance	50Ω		
DC Resistance	50 ± 0.50Ω	Insertion Loss	≤0.15dB		
Max Power	0.25W	Electrical Length	29.3+/-0.12mm		
Return Loss	DC-6GHz	≥42dB	Return Loss	DC-6GHz	≥32dB
	6-18GHz	≥30 dB		6-18GHz	≥28dB

Parts	Material	Plating (Micro-inch)
Housing	Aluminium	Anodized (Green)
Cap	PVC	
Body open/short/load/adaptor	Stainless Steel	Passivated
Contact pin open/short/load/ through adaptors	Beryllium Copper	Gold 4 Over Nickel Phosphorous Alloy 80 Over Copper 20
Dielectric	Teflon	

This part number complies with RoHS.

Notice: JYEBAO reserves the right to make modifications deemed appropriate.

OSLT-SMA-M-18G

OPEN return loss & phase error

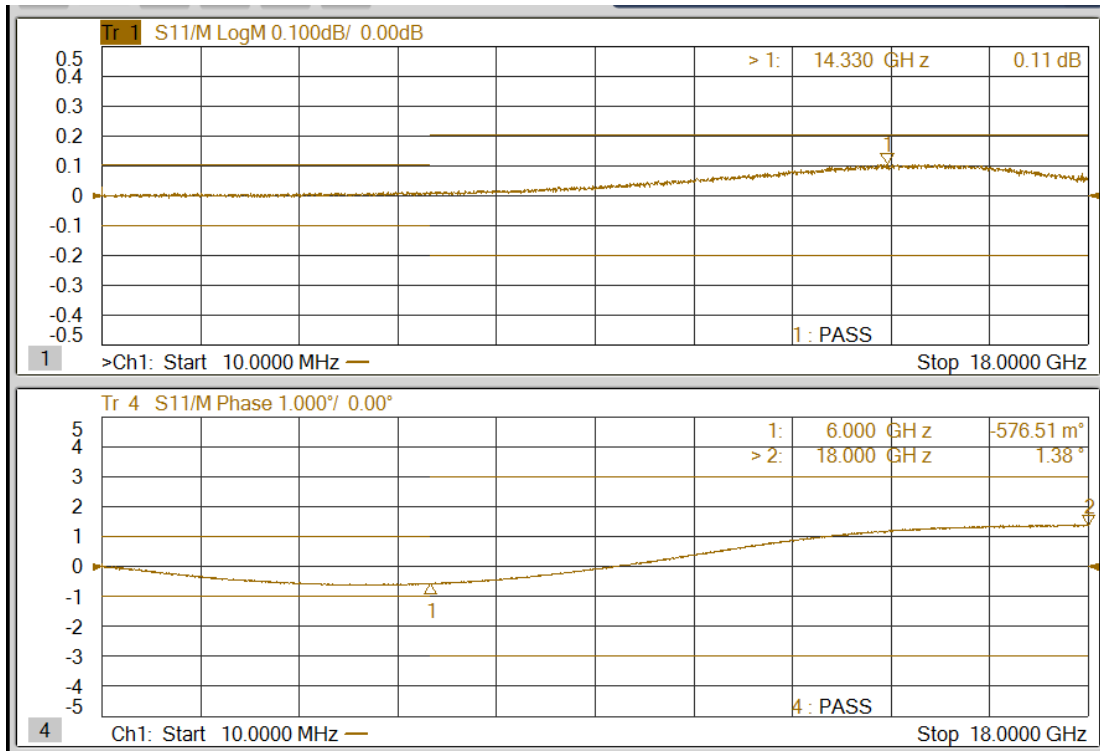

SHORT return loss & phase error

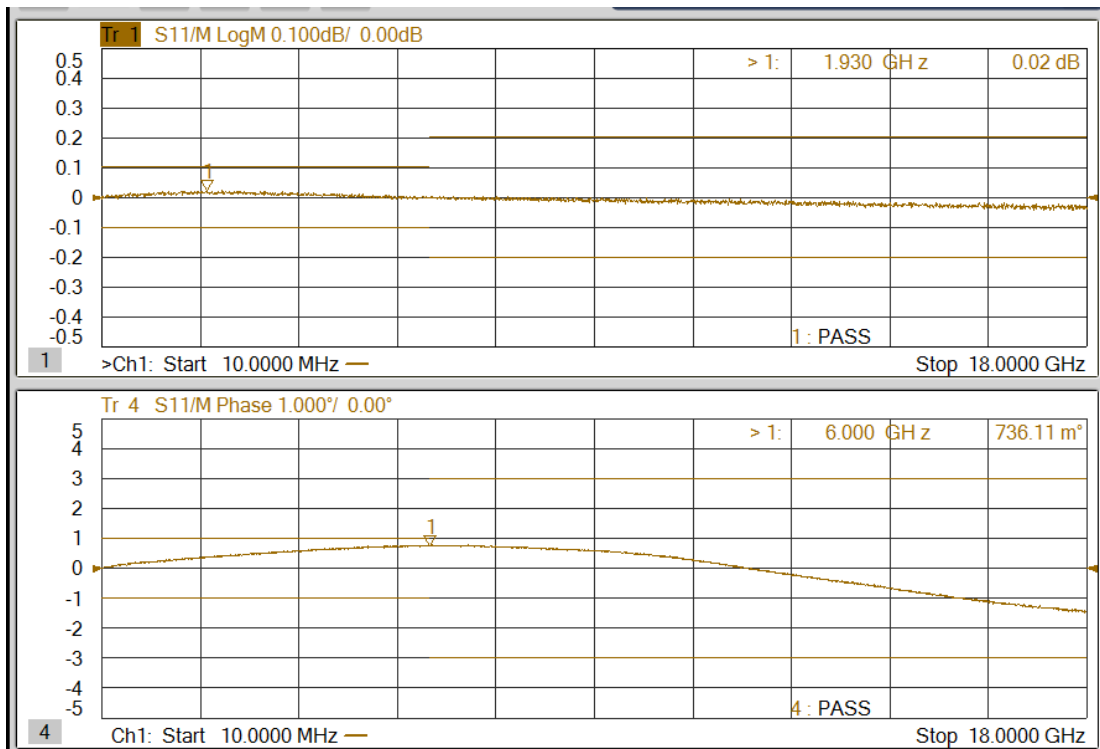

LOAD return loss

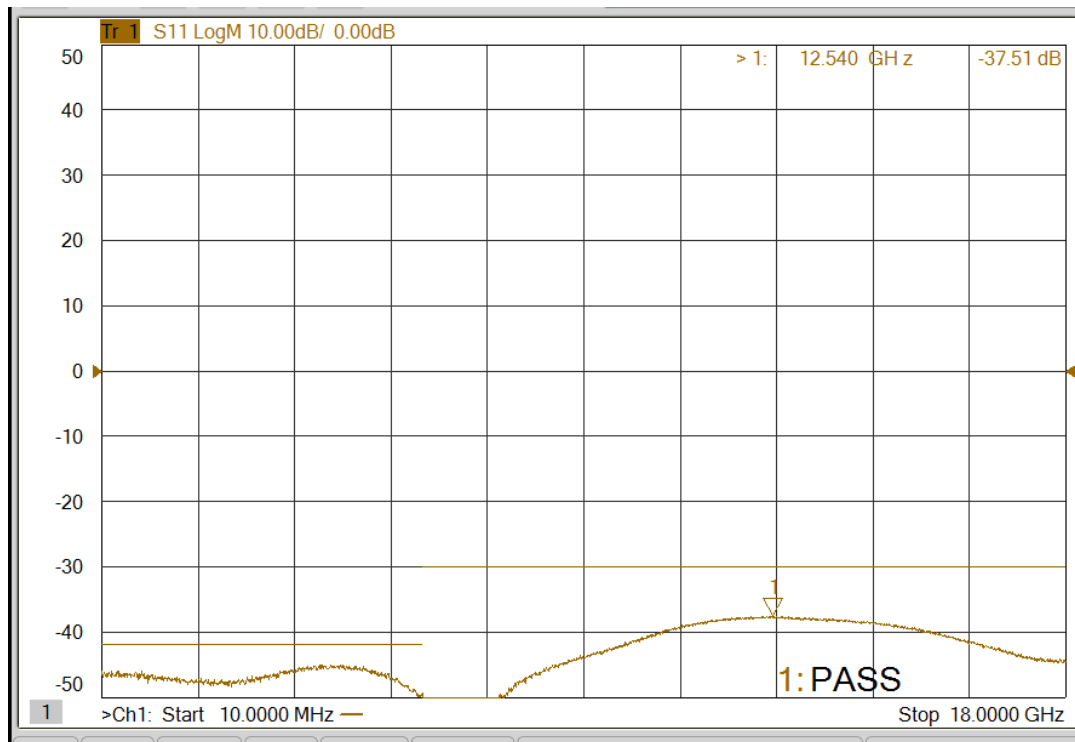

Thru male-male insertion & return loss

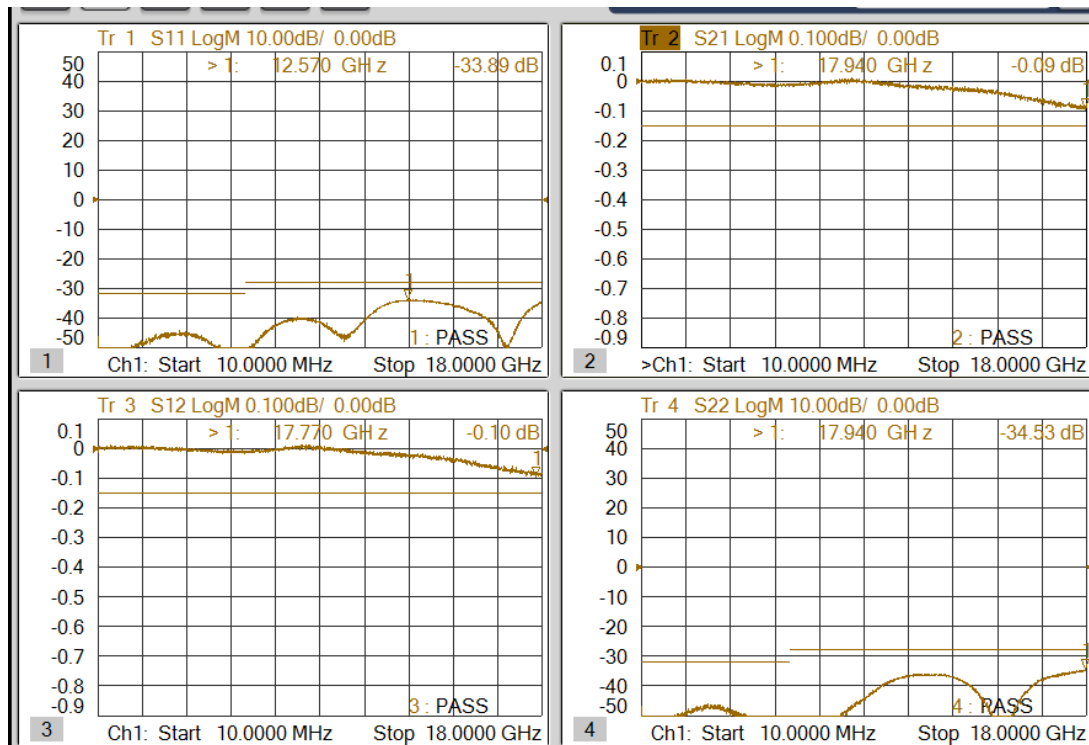

Thru male-male electrical length: 29.3mm

Thru male-female insertion & return loss

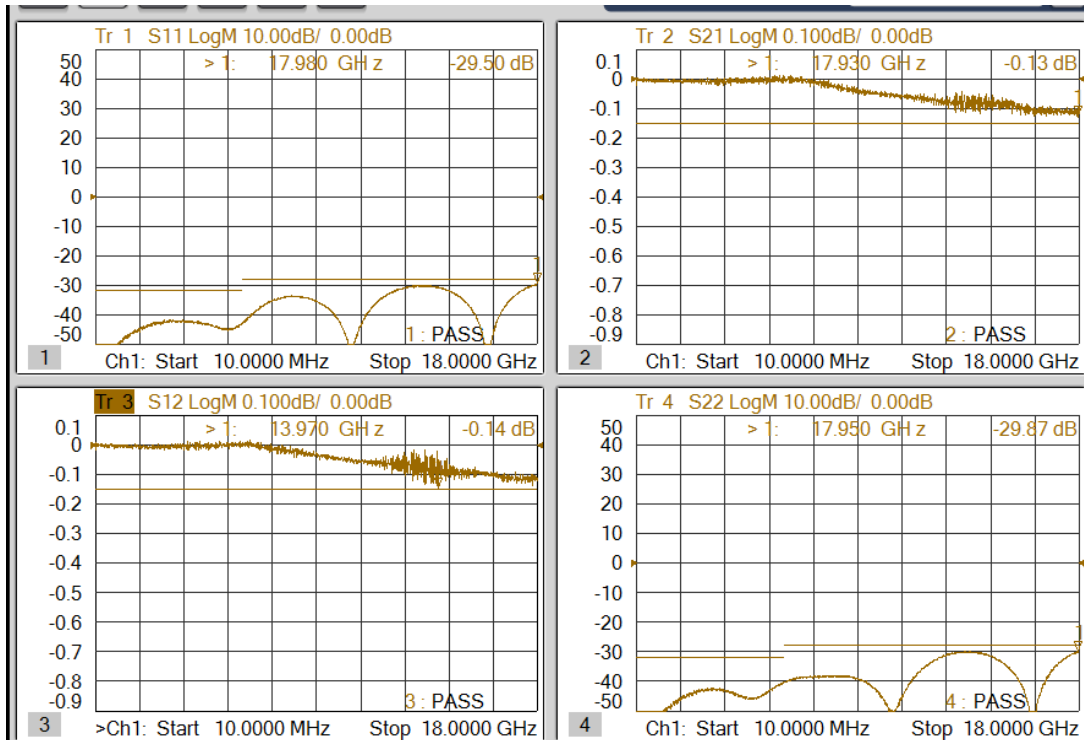

Thru male-female electrical length: 29.3mm

Thru female-female insertion & return loss

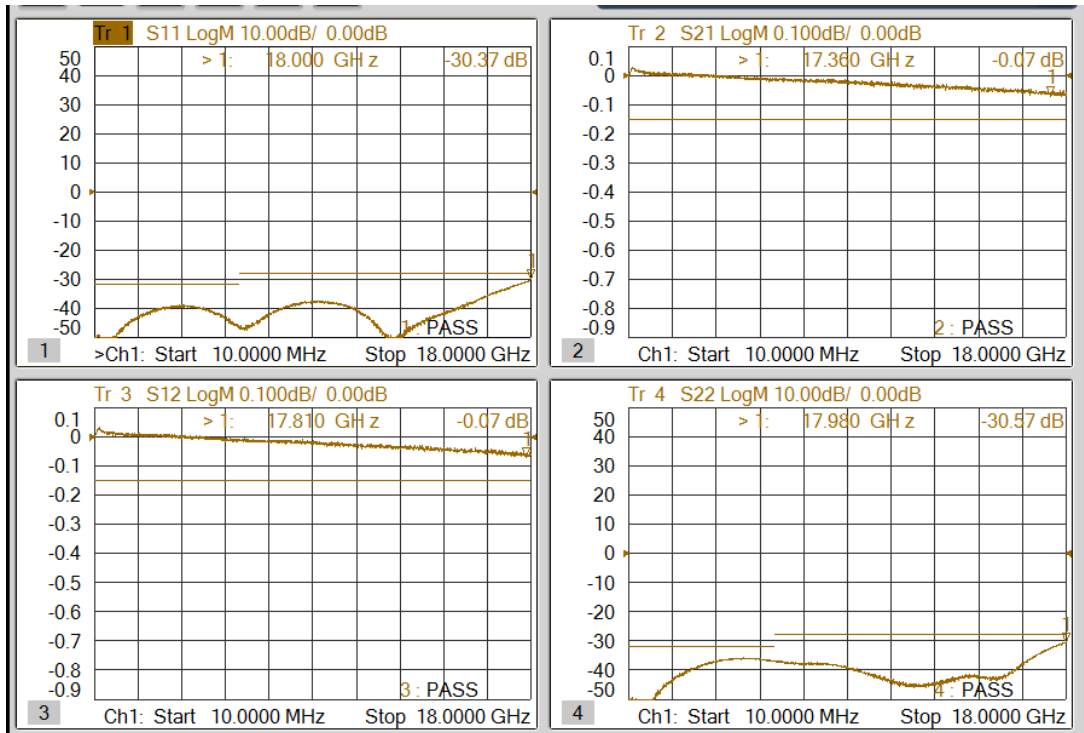

Thru female-female electrical length: 29.3mm