

NO.	COMPONENTS	IMPEDANCE
1	N FEMALE FOR BULKHEAD	50 OHM
2	RG316	50 OHM
3	HEAT SHRINKING TUBE	
4	TNC REVERSE POLARITY MALE	50 OHM

REVISION			
REV.	DESCRIPTION	DATE	APPROVED
-	INITIAL RELEASE	2012/08/15	

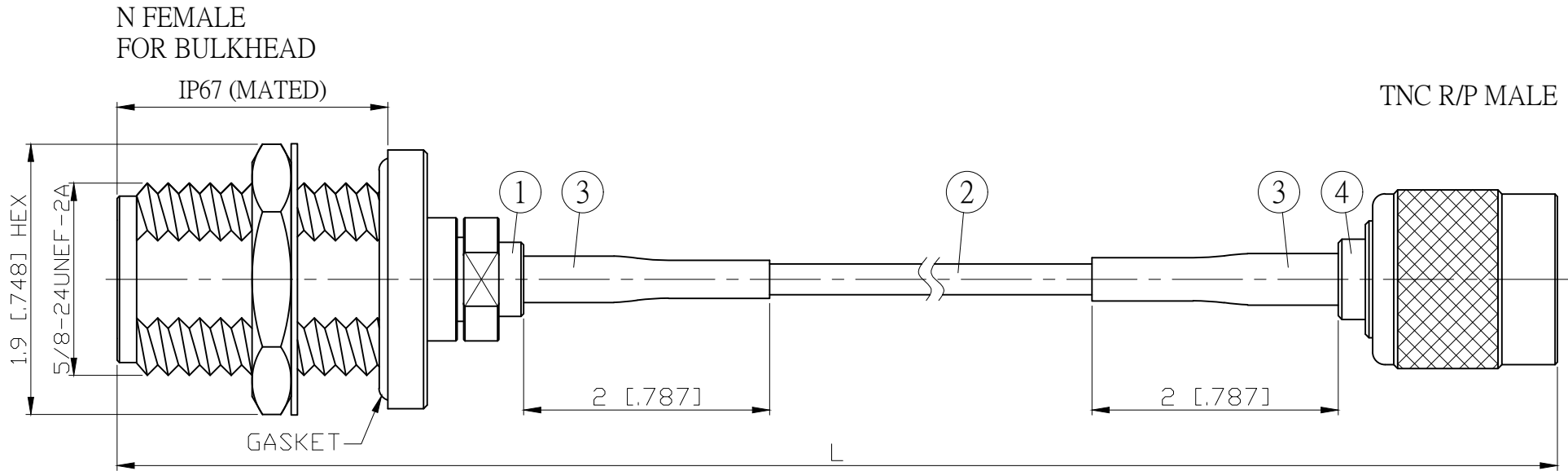

JYE BAO P/N	L CM (INCH)	L1 FT (MM)
N85T60-316-15	15 (5.906)	0.400 (122.0)
N85T60-316-30	30 (11.811)	0.892 (272.0)
N85T60-316-50	50 (19.685)	1.549 (472.0)
N85T60-316-100	100 (39.370)	3.189 (972.0)
N85T60-316-150	150 (59.055)	4.829 (1472.0)
N85T60-316-200	200 (78.740)	6.470 (1972.0)
N85T60-316-XXX	CUSTOM LENGTH IN CM	- - -

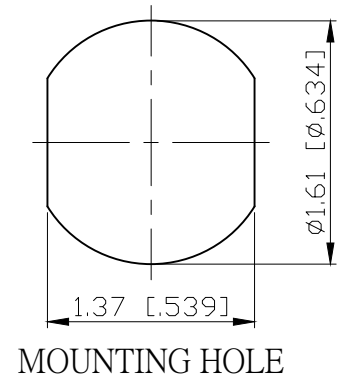

4	TNC6100-0316	TNC R/P PLUG	1	EA
3	G5(F)-4.0MM-BLACK	TUBE	0.04	M
2	RG316	CABLE	L1 (SEE TABLE)	FT
1	N8105P-0316	N JACK	1	EA
NO.	PARTS NO.	DESCRIPTION	QTY	UM

LENGTH TOLERANCE IS ±1.5% OR ±10MM, WHICHEVER IS GREATER.	STANDARD	REV -	UNIT CM(INCH)
	APPROVED		DATE
	CHECKED		DATE
	DRAWING Albert		DATE

JYE BAO CO., LTD.	
TAIPEI TAIWAN	
DESCRIPTION	CABLE ASSEMBLY N JACK FOR BULKHEAD TO TNC R/P PLUG
JYE BAO DRAWING NO.	N85T60-316-XXX