

NO.	COMPONENTS	IMPEDANCE
1	N FEMALE FOR BULKHEAD	75 OHM
2	RG59	75 OHM
3	HEAT SHRINKING TUBE	
4	TNC MALE RIGHT ANGLE	75 OHM

REVISION			
REV.	DESCRIPTION	DATE	APPROVED
-	INITIAL RELEASE	2012/08/15	

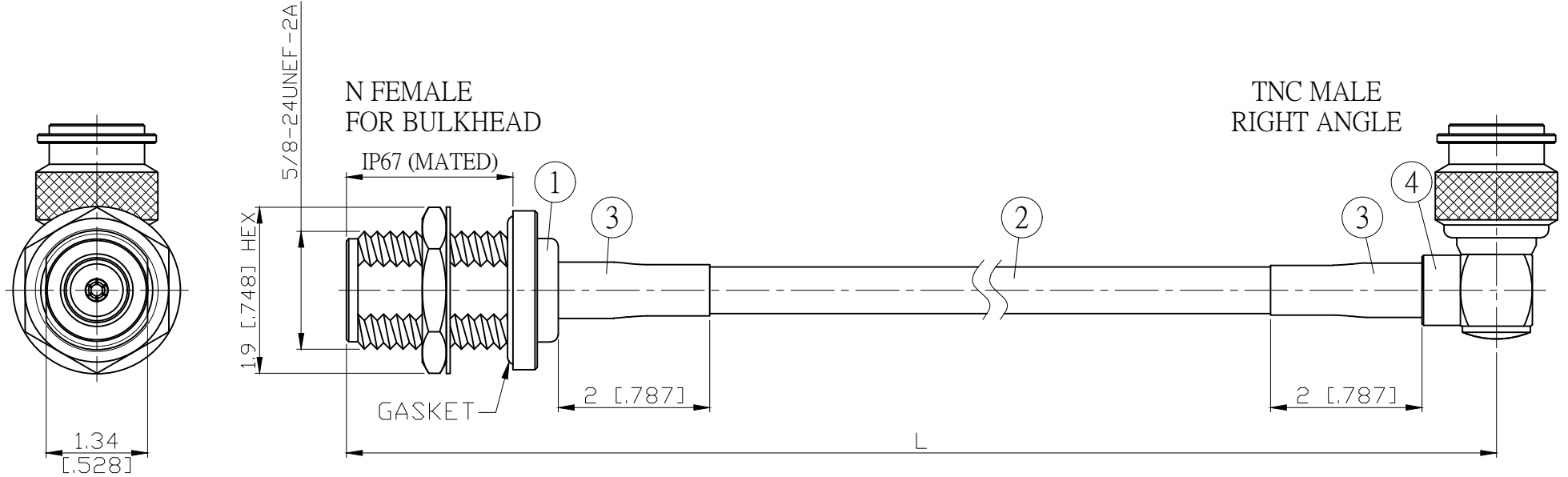

JYE BAO P/N	L CM (INCH)	L1 FT (MM)
N85T39-59-15	15 (5.906)	0.427 (130.0)
N85T39-59-30	30 (11.811)	0.919 (280.0)
N85T39-59-50	50 (19.685)	1.575 (480.0)
N85T39-59-100	100 (39.370)	3.215 (980.0)
N85T39-59-150	150 (59.055)	4.856 (1480.0)
N85T39-59-200	200 (78.740)	6.496 (1980.0)
N85T39-59-XXX	CUSTOM LENGTH IN CM	- - -

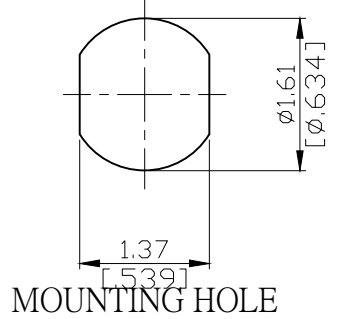

NO.	PARTS NO.	DESCRIPTION	QTY	U/M
4	TNC3100-9059	TNC PLUG R/A	1	EA
3	G5(F)-8.0MM-BLACK	TUBE	0.04	M
2	RG59	CABLE	L1 (SEE TABLE)	FT
1	N8105-0059	N JACK	1	EA

LENGTH TOLERANCE IS ±1.5% OR ±10MM, WHICHEVER IS GREATER.	STANDARD	REV -	UNIT CM(INCH)
	APPROVED		DATE
	CHECKED		DATE
	DRAWING Albert		DATE

JYE BAO CO., LTD.	
TAIPEI TAIWAN	
DESCRIPTION	CABLE ASSEMBLY N JACK FOR BULKHEAD TO TNC PLUG R/A
JYE BAO DRAWING NO.	N85T39-59-XXX