

NO.	COMPONENTS	IMPEDANCE
1	N FEMALE FOR BULKHEAD	50 OHM
2	.085" TIN PLATED SEMI-RIGID CABLE (TIN PLATED RG405)	50 OHM
3	BNC REVERSE POLARITY MALE	50 OHM

REVISION			
REV.	DESCRIPTION	DATE	APPROVED
-	INITIAL RELEASE	2012/08/15	

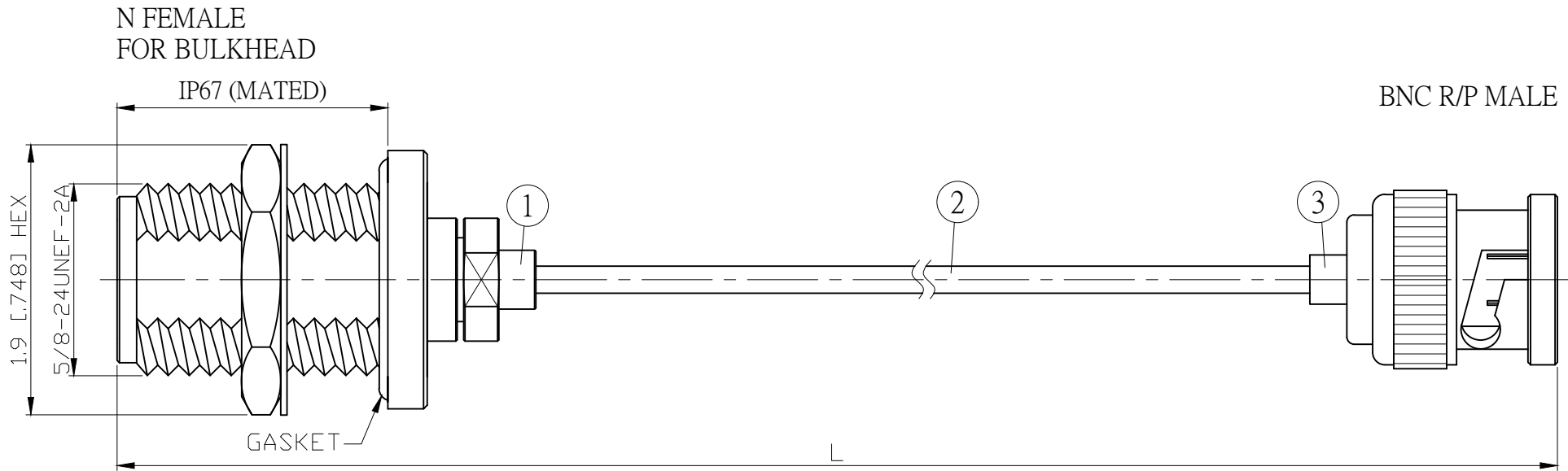

JYE BAO P/N	L CM (INCH)	L1 FT (MM)
N85B60-85T-15	15 (5.906)	0.404 (123.0)
N85B60-85T-30	30 (11.811)	0.896 (273.0)
N85B60-85T-50	50 (19.685)	1.552 (473.0)
N85B60-85T-100	100 (39.370)	3.192 (973.0)
N85B60-85T-150	150 (59.055)	4.833 (1473.0)
N85B60-85T-200	200 (78.740)	6.473 (1973.0)
N85B60-85T-XXX	CUSTOM LENGTH IN CM	- - -

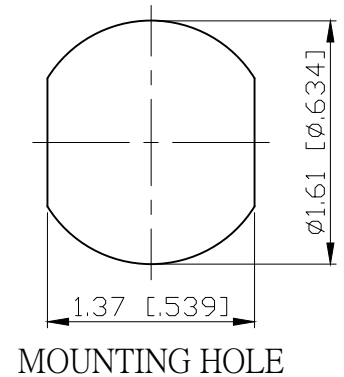

3	BNC6300-0085	BNC R/P PLUG	1	EA
2	.085TIN-W-P-50	CABLE	L1 (SEE TABLE)	FT
1	N8305P-0085	N JACK	1	EA
NO.	PARTS NO.	DESCRIPTION	QTY	UM

LENGTH TOLERANCE IS ±1.5% OR ±10MM, WHICHEVER IS GREATER.	STANDARD	REV -	UNIT CM(INCH)
	APPROVED		DATE
	CHECKED		DATE
	DRAWING Albert		DATE

JYE BAO CO., LTD.	
TAIPEI TAIWAN	
DESCRIPTION	CABLE ASSEMBLY N JACK FOR BULKHEAD TO BNC R/P PLUG
JYE BAO DRAWING NO.	N85B60-85T-XXX