

NO.	COMPONENTS	IMPEDANCE
1	N FEMALE FOR BULKHEAD	50 OHM
2	RG58	50 OHM
3	HEAT SHRINKING TUBE	
4	BNC MALE RIGHT ANGLE	50 OHM

REVISION			
REV.	DESCRIPTION	DATE	APPROVED
-	INITIAL RELEASE	2012/06/06	

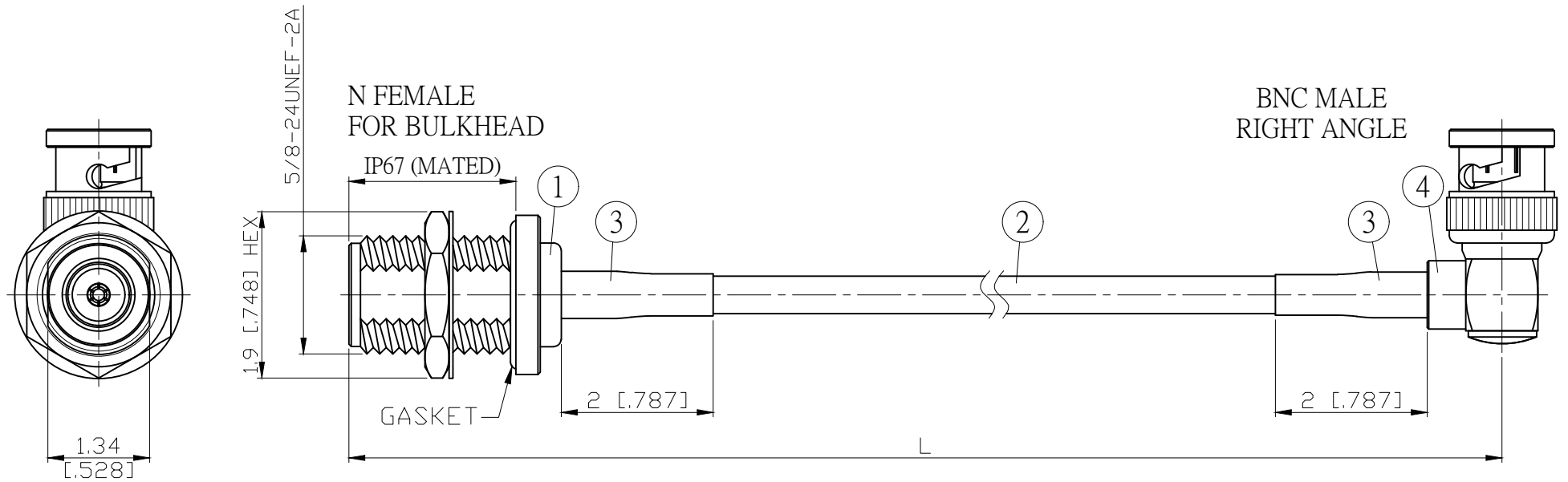

JYE BAO P/N	L CM (INCH)	L1 FT (MM)
N85B39-58-15	15 (5.906)	0.431 (131.5)
N85B39-58-30	30 (11.811)	0.924 (281.5)
N85B39-58-50	50 (19.685)	1.580 (481.5)
N85B39-58-100	100 (39.370)	3.220 (981.5)
N85B39-58-150	150 (59.055)	4.861 (1481.5)
N85B39-58-200	200 (78.740)	6.501 (1981.5)
N85B39-58-XXX	CUSTOM LENGTH IN CM	- - -

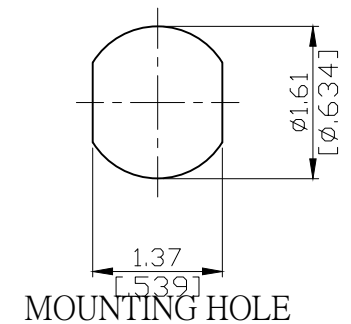

					STANDARD	REV -	UNIT CM(INCH)	JYE BAO CO., LTD.	
					APPROVED			TAIPEI TAIWAN	
					CHECKED			DESCRIPTION CABLE ASSEMBLY N JACK FOR BULKHEAD TO BNC PLUG R/A	
					DRAWING			JYE BAO DRAWING NO. N85B39-58-XXX	
					Albert				
4	BNC3100-9058	BNC PLUG R/A	1	EA	LENGTH TOLERANCE IS ±1.5% OR ±10MM, WHICHEVER IS GREATER.				
3	G5(F)-8.0MM-BLACK	TUBE	0.04	M					
2	RG58	CABLE	L1 (SEE TABLE)	FT					
1	N8105-0058	N JACK	1	EA					
NO.	PARTS NO.	DESCRIPTION	QTY	UM					