

NO.	COMPONENTS	IMPEDANCE
1	N FEMALE	50 OHM
2	.085" TIN PLATED SEMI-RIGID CABLE (TIN PLATED RG405)	50 OHM
3	TNC REVERSE POLARITY FEMALE	50 OHM

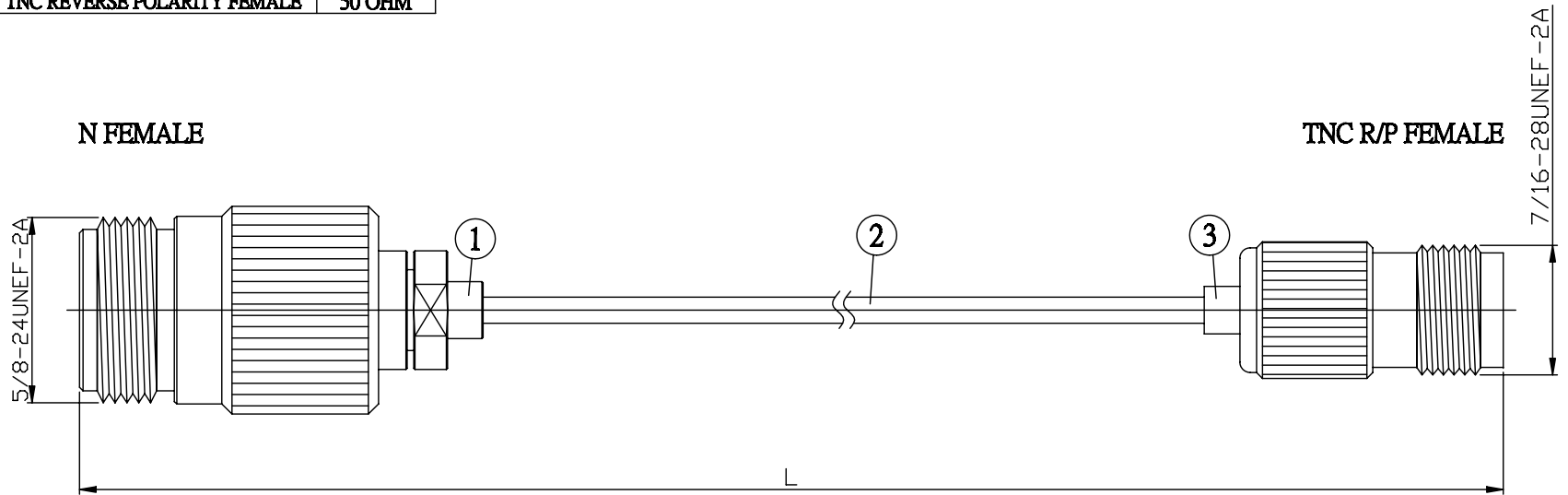

JYE BAO P/N	L CM (INCH)
N80T90-85T-15	15 (5.906)
N80T90-85T-30	30 (11.811)
N80T90-85T-50	50 (19.685)
N80T90-85T-100	100 (39.370)
N80T90-85T-150	150 (59.055)
N80T90-85T-200	200 (78.740)
N80T90-85T-XXX	CUSTOM LENGTH IN CM

LENGTH TOLERANCE IS $\pm 1.5\%$ OR $\pm 10\text{MM}$ , WHICHEVER IS GREATER.	<b>JYE BAO CO., LTD.</b> TAIPEI TAIWAN
	DESCRIPTION CABLE ASSEMBLY N JACK TO TNC R/P JACK
	JYE BAO DRAWING NO. N80T90-85T-XXX