

NO.	COMPONENTS	IMPEDANCE
1	N MALE RIGHT ANGLE	50 OHM
2	RG58	50 OHM
3	HEAT SHRINKING TUBE	
4	TNC MALE	50 OHM

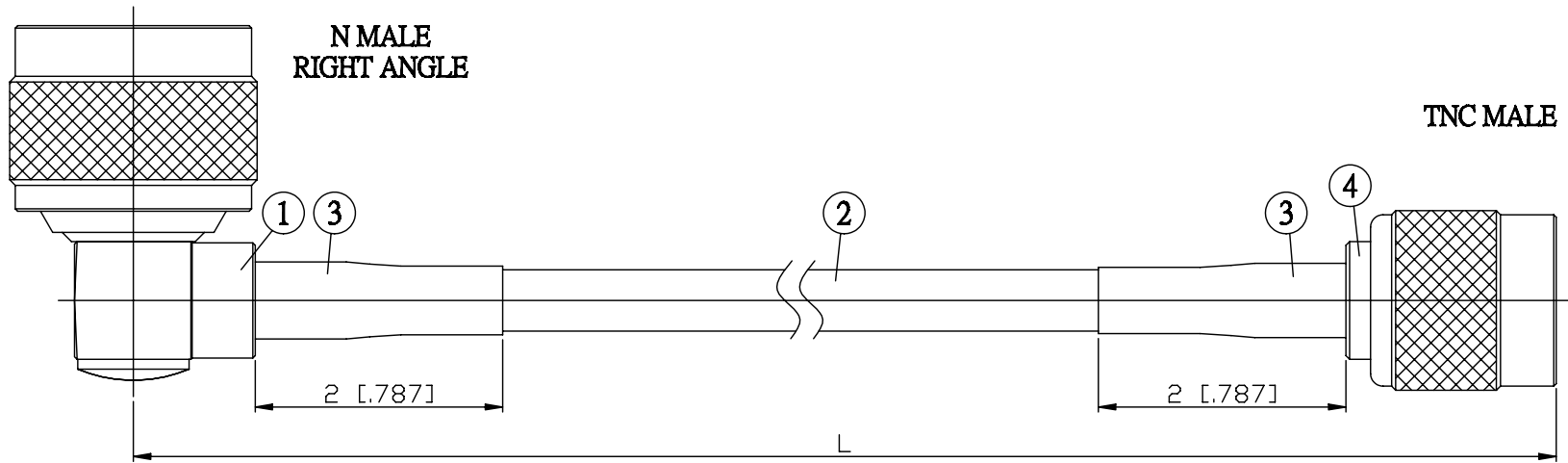

JYE BAO P/N	L CM (INCH)
N39T30-58-15	15 (5.906)
N39T30-58-30	30 (11.811)
N39T30-58-50	50 (19.685)
N39T30-58-100	100 (39.370)
N39T30-58-150	150 (59.055)
N39T30-58-200	200 (78.740)
N39T30-58-XXX	CUSTOM LENGTH IN CM

LENGTH TOLERANCE IS ±1.5% OR ±10MM, WHICHEVER IS GREATER.	JYE BAO CO., LTD. TAIPEI TAIWAN
	<small>DESCRIPTION</small> CABLE ASSEMBLY N PLUG R/A TO TNC PLUG
	<small>JYE BAO DRAWING NO.</small> N39T30-58-XXX