

NO.	COMPONENTS	IMPEDANCE
1	SMC MALE RIGHT ANGLE	50 OHM
2	.085" TIN PLATED SEMI-RIGID CABLE (TIN PLATED RG405)	50 OHM
3	SMC FEMALE FOR BULKHEAD	50 OHM

SMC MALE
RIGHT ANGLE

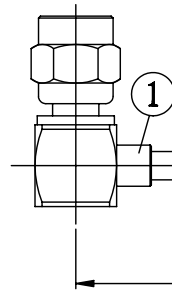

2



L

SMC FEMALE
FOR BULKHEAD

3

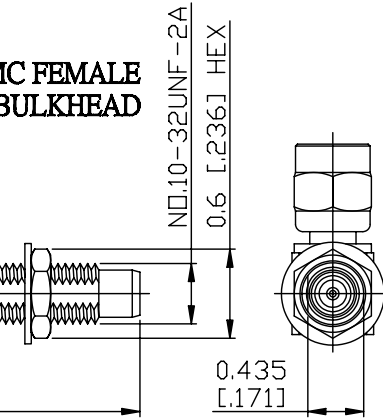

JYE BAO P/N	L CM (INCH)
MC39MC85-85T-15	15 (5.906)
MC39MC85-85T-30	30 (11.811)
MC39MC85-85T-50	50 (19.685)
MC39MC85-85T-100	100 (39.370)
MC39MC85-85T-150	150 (59.055)
MC39MC85-85T-200	200 (78.740)
MC39MC85-85T-XXX	CUSTOM LENGTH IN CM

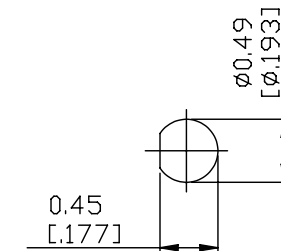

MOUNTING HOLE

<p>LENGTH TOLERANCE IS ±1.5% OR ±10MM, WHICHEVER IS GREATER.</p>	<p>JYE BAO CO., LTD.</p> <p>TAIPEI TAIWAN</p>
	<p>DESCRIPTION CABLE ASSEMBLY SMC PLUG R/A TO SMC JACK FOR BULKHEAD</p>
	<p>JYE BAO DRAWING NO. MC39MC85-85T-XXX</p>