

L-N-M-50-6G

N Plug 50ohm Termination
6GHz 42dB

50Ω

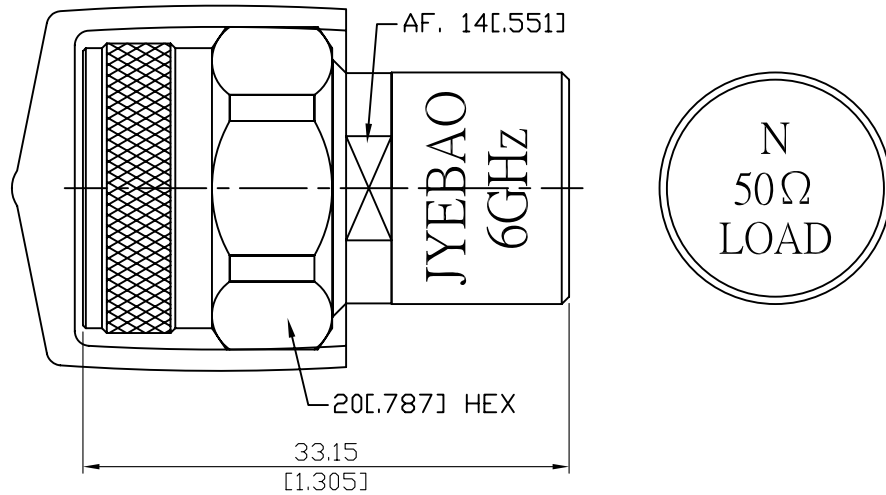

LOAD	
FREQUENCY RANGE	DC-6GHz
IMPEDANCE	50Ω
DC RESISTANCE	50±0.50Ω
MAX POWER	0.5W
RETURN LOSS	DC-6GHz ≥ 42dB

Notes:

1. Temperature range for optimal results: +20 °C to +26 °C
2. Storage temperature range: -20 °C to +75°C
3. When not in use put on cap to keep connector clean
4. Return loss test results shipped along with goods

Parts	Material	Plating (Micro-inch)
Cover	Aluminium	Anodized(Green)
Retainer Ring	Beryllium Copper	Tin-Zinc-Copper-Alloy 100 Over Copper 50
Gasket	Silicone	
Contact Pin	Beryllium Copper	Gold 4 Over Nickel-Phosphorus Alloy 80 Over Copper 20
Insulator	PPO	
Body	Brass	Tin-Zinc-Copper-Alloy 100 Over Copper 50
Coupling Nut	Stainless	Passivated
Cap	PVC	

This part number complies with RoHS.

Notice: JYEBAO reserves the right to make modifications deemed appropriate.

L-N-M-50-6G

LOAD return loss

