

K3900S-0040-1.25

1 Watt 50ohm 2.92mm Plug Termination
40GHz VSWR 1.25

50Ω

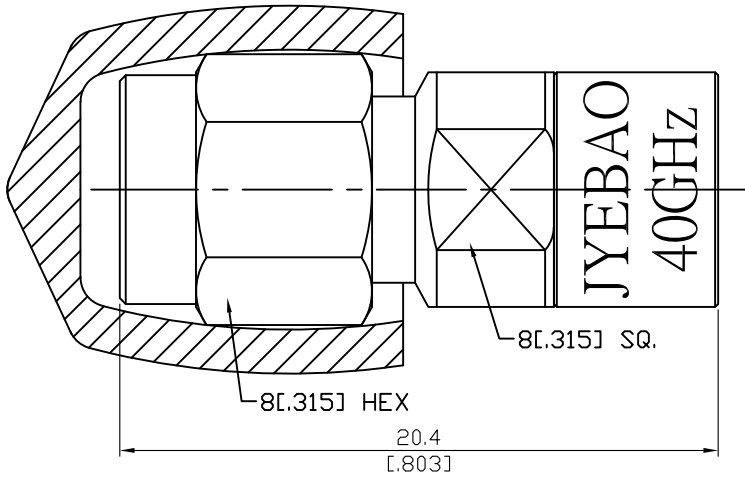

1 W Average Power From -40°C to 70°C Linearly Derated To 0.7 Watt at 105°C

Parts	Material	Plating (Micro-inch)
Retainer Ring	Beryllium Copper	Tin-Zinc-Copper-Alloy 100 Over Copper 50
Gasket	Silicone	
Contact Pin	Beryllium Copper	Gold 4 Over Nickel-Phosphorus Alloy 80 Over Copper 20
Insulator	PPO	
Body	Stainless Steel	Passivated
Coupling Nut	Stainless Steel	Passivated
Dust Cap	PVC	
Cover	Aluminum	Anodized(Green)

This part number complies with RoHS.

Notice: JYEBAO reserves the right to make modifications deemed appropriate.

2.92 (K)	K3900S-0040-1.25
<div style="border: 1px solid black; padding: 2px; margin-bottom: 5px;">Interface</div> <p>MIL-STD-348B</p> <p>Mechanically compatible with 3.5 & SMA</p>	
<div style="border: 1px solid black; padding: 2px; margin-bottom: 5px;">Electrical Data</div> <p>Impedance 50Ω</p> <p>Frequency range DC to 40GHz</p> <p>VSWR ≤ 1.25 (DC to 40GHz)</p> <p>Insertion loss $\leq 0.04 \times \sqrt{f(\text{GHz})}$ dB</p> <p>Insulation resistance $\geq 5000\text{M}\Omega$</p> <p>Contact resistance inner conductor $\leq 3\text{m}\Omega$</p> <p>Contact resistance outer conductor $\leq 2\text{m}\Omega$</p> <p>Dielectric withstanding voltage (at sea level) 750 V rms</p> <p>Working Voltage (at sea level) 250 V rms</p> <p>RF leakage $\geq 100\text{dB}$ to 1GHz</p>	
<div style="border: 1px solid black; padding: 2px; margin-bottom: 5px;">Mechanical Data</div> <p>Recommended coupling nut torque 11.47 inch lbs</p> <p>Coupling proof torque 15 inch lbs</p> <p>Contact Captivation-axial ≥ 4.9 lbs</p> <p>Durability (mating) ≥ 500</p>	
<div style="border: 1px solid black; padding: 2px; margin-bottom: 5px;">Environmental Data</div> <p>Temperature range -40°C to +105°C</p> <p>Thermal shock MIL-STD-202, Method 107, Condition B</p> <p>Moisture resistance MIL-STD-202, Method 206</p> <p>Corrosion MIL-STD-202, Method 101, Condition B</p> <p>RoHS Compliant</p>	
<div style="border: 1px solid black; padding: 2px; margin-bottom: 5px;">Tooling</div>	

Notice: JYEBAO reserves the right to make modifications deemed appropriate.