

FR015-LAUNCH2

Launch pin & dielectric for $\phi 0.38\text{mm}$ (.015inch)
Field Replaceable Connector

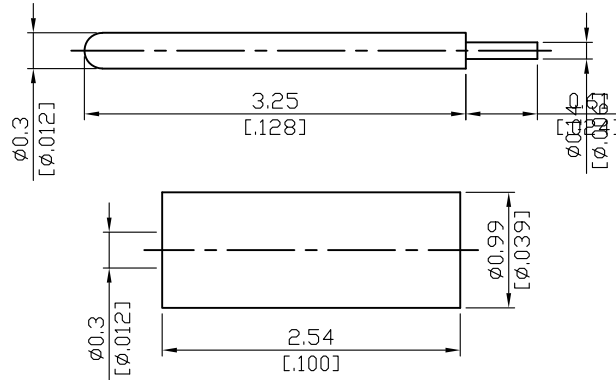

Application:

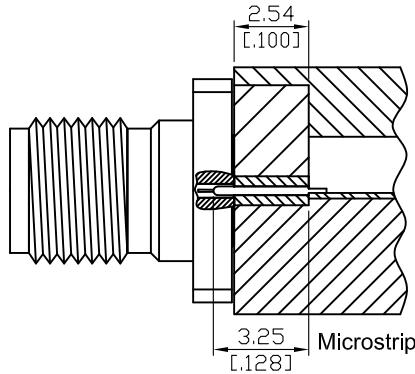

FR015-LAUNCH2 can be used with the following connector PN's:

2.4mm
2.4-3F26A-EM15
2.4-3F26B-EM15
2.4-3F26E-EM15
2.4-3F46C-EM15
2.4-3F46D-EM15
2.4-8F26A-EM15
2.4-8F26B-EM15
2.4-8F26E-EM15
2.4-8F46C-EM15
2.4-8F46D-EM15
2.4-8F26A-GA15
2.4-8F26B-GA15
2.4-8F26E-GA15
2.4-8F46C-GA15
2.4-8F46D-GA15

2.92mm
K3F26A-EM15
K3F26B-EM15
K3F26E-EM15
K3F46C-EM15
K3F46D-EM15
K8F26A-EM15
K8F26B-EM15
K8F26E-EM15
K8F46C-EM15
K8F46D-EM15
K8F26A-GA15
K8F26B-GA15
K8F26E-GA15
K8F46C-GA15
K8F46D-GA15

SMA Male
SMA3F00-12/15
SMA3F26A-0015
SMA3F26B-0015
SMA3F46C-0015
SMA3F46D-0015
SMA3F26EA-EM15
SMA3F26EC-EM15
SMA3F26EE-EM15
SMA3F46EC-EM15
SMA3F46ED-EM15
N
N8F46EC-EM15
N8F46ED-EM15
TERMINAL
TER0F26A-0015

SMA Jack
SMA8F00-125/15
SMA8F26EA-EM15
SMA8F26EC-EM15
SMA8F26EE-EM15
SMA8F46EC-EM15
SMA8F46ED-EM15
SMA8F26EA-GA15
SMA8F26EC-GA15
SMA8F26EE-GA15
SMA8F46EC-GA15
SMA8F46ED-GA15
TNC
TNC8F46EC-EM15

Parts	Material	Plating (Micro-inch)
Contact Pin	Beryllium Copper	Gold 4 Over Nickel-Phosphorus Alloy 80 Over Copper 20
Insulator	Teflon	

This part number complies with RoHS.

Notice: JYEBAO reserves the right to make modifications deemed appropriate.