

FAT-NM5NF5T1G1W6

1GHz 1 Watt N Plug To N Jack
Fixed Attenuator

50Ω

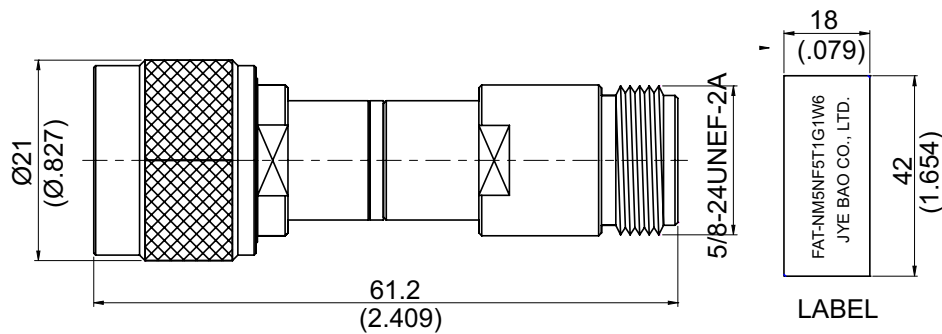

Attenuation	VSWR	Attenuation deviation (+/-dB)
	DC-1GHz	DC-1GHz
6dB	≤1.25	+/-0.5dB

Parts	Material	Plating (Micro-inch)
Insulator	Teflon	
Contact Pin(Jack)	Beryllium Copper	Gold 4 Over Nickel-Phosphorus Alloy 80 Over Copper 20
Body	Brass	Tin-Zinc-Copper-Alloy 100 Over Copper 50
Retainer Ring	Brass	Tin-Zinc-Copper-Alloy 100 Over Copper 50
Gasket	Silicon	
Contact Pin(Plug)	Brass	Gold 4 Over Nickel-Phosphorus Alloy 80 Over Copper 20
Coupling Nut	Brass	Tin-Zinc-Copper-Alloy 100 Over Copper 50

Weight:

This part number complies with RoHS.

Notice: JYEBAO reserves the right to make modifications deemed appropriate.