

FAT-NM5A95T6G2W2

6GHz N Plug To SMA Reverse Polarity Jack Fixed Attenuator

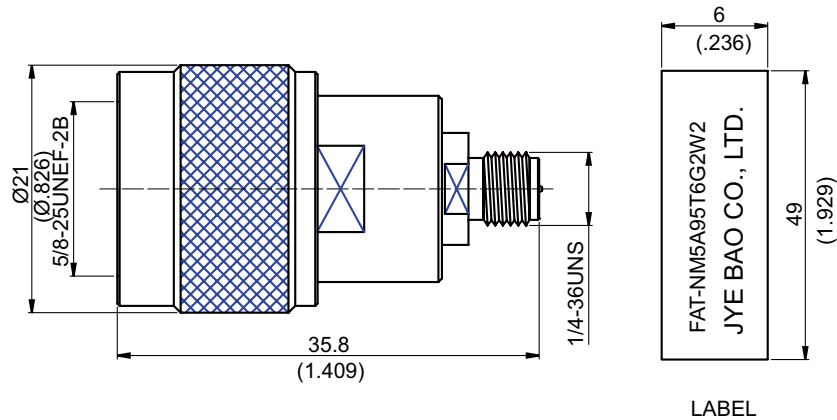

Nominal impedance: 50Ω+/-0.25Ω over operating temperature range.
 Operating temperature range: -50 degrees Celcius to +80 degrees Celcius.
 VSWR deviation: +/-0.1% over operating temperature range.
 Power rating: 2W over operating temperature range.
 Power Rating (Peak): 100W for 25 Microseconds.
 Power Coefficient: 0.001dB/W (change in attenuation with increase in power).
 Temperature Coefficient: 0.001dB/Deg. C max., 0.0003dB/Deg.C typ.

Attenuation	VSWR			Attenuation deviation (+/-dB)		
	DC-2GHz	2-5GHz	5-6GHz	DC-2GHz	2-5GHz	5-6GHz
2dB	≤1.1	≤1.25	≤1.35	+/-0.2dB	+/-0.3dB	+/-0.5dB

Parts	Material	Plating (Micro-inch)
Body	Brass	Tin-Zinc-Copper-Alloy 100 Over Copper 50
Insulator	Teflon	
Contact Pin(SMA)	Phospher Bronze	Gold 20 Over Nickel 50 Over Copper 50
Renbrock Ring	Beryllium Copper	Tin-Zinc-Copper-Alloy 100 Over Copper 50
Gasket	Silicon	
Contact Pin(N)	Brass	Gold 5 Over Nickel 50 Over Copper 50
Coupling Nut	Brass	Tin-Zinc-Copper-Alloy 100 Over Copper 50

Weight:

This part number complies with RoHS.

Notice: JYEBAO reserves the right to make modifications deemed appropriate.