

FAT-JM5NBF5T10G2W4 **4dB 50ohm Fixed Attenuator BMA Plug To N Jack Bulkhead 10GHz Rated 2 Watt** **50Ω**

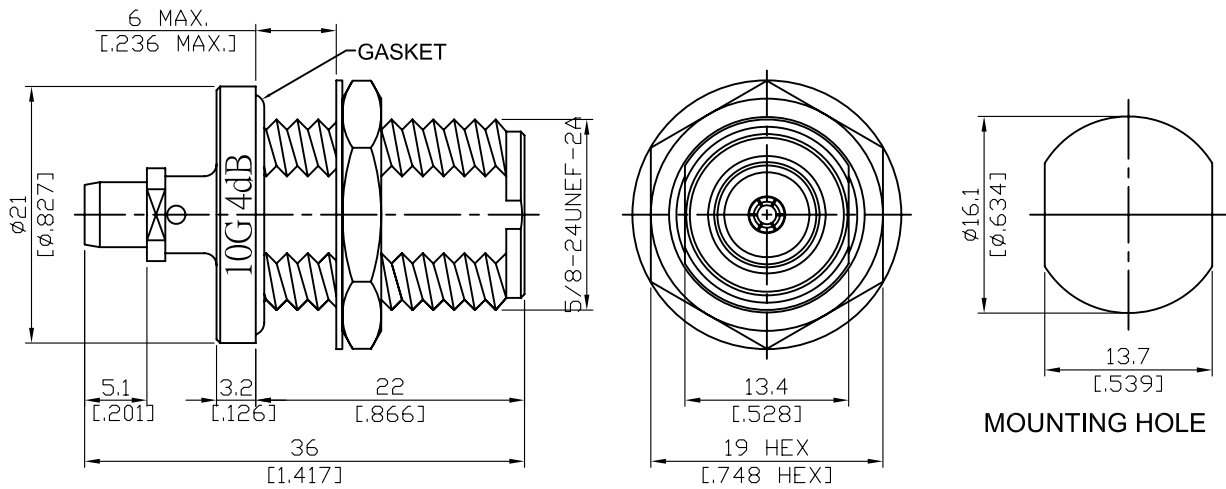

Nominal impedance: $50\Omega \pm 0.25\Omega$ over operating temperature range.
 Operating temperature range: -50 degrees Celcius to +80 degrees Celcius.
 VSWR deviation: $\pm 0.1\%$ over operating temperature range.
 Power rating: 2W over operating temperature range.
 Power rating (Peak): 100W for 25 Microseconds.
 Power coefficient: 0.001dB/W (change in attenuation with increase in power).
 Temperature coefficient: 0.001dB/Deg. C max., 0.0003dB/Deg. C type.

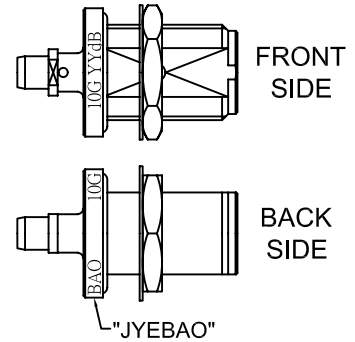

Attenuation	VSWR			Attenuation deviation (\pm dB)		
	DC~2GHz	2~5GHz	5~10GHz	DC~2GHz	2~5GHz	5~10GHz
4dB	≤ 1.15	≤ 1.25	≤ 1.35	± 0.2 dB	± 0.4 dB	± 0.7 dB

Parts	Material	Plating (Micro-inch)
Hex Nut	Brass	Tin-Zinc-Copper-Alloy 100 Over Copper 50
Lock Washer	Brass	Tin-Zinc-Copper-Alloy 100 Over Copper 50
Gasket	Silicone	
Contact Pin	Beryllium Copper	Gold 4 Over Nickel-Phosphorus Alloy 80 Over Copper 20
Body	Brass	Tin-Zinc-Copper-Alloy 100 Over Copper 50

Weight: 37.19 g