

**FAT-JM5NBF5T10G2W3**      **3dB 50ohm Fixed Attenuator BMA Plug To N Jack Bulkhead 10GHz Rated 2 Watt**      **50Ω**

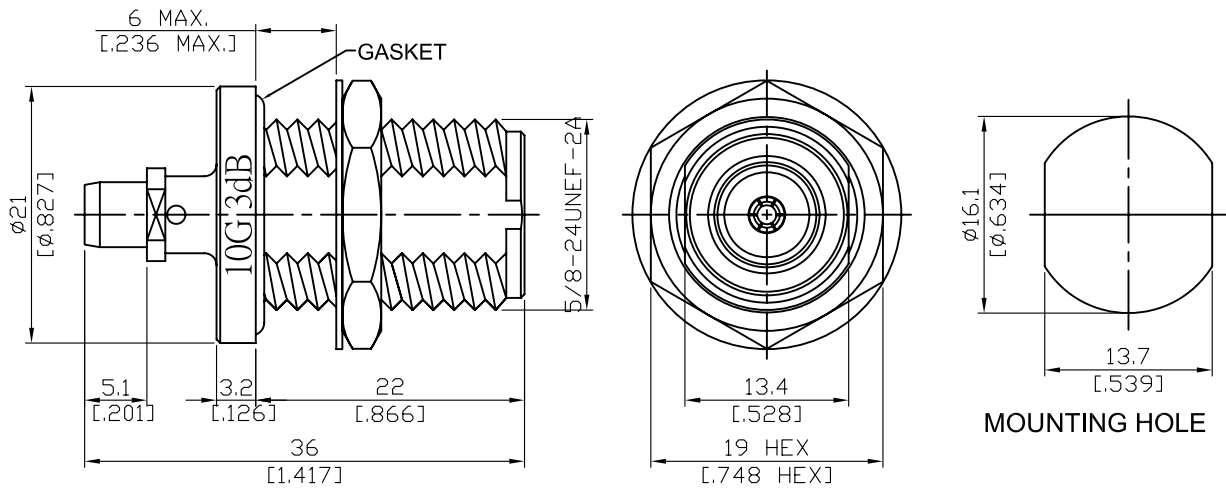

Nominal impedance: 50Ω±0.25Ω over operating temperature range.  
 Operating temperature range: -50 degrees Celcius to +80 degrees Celcius.  
 VSWR deviation: ±0.1% over operating temperature range.  
 Power rating: 2W over operating temperature range.  
 Power rating (Peak): 100W for 25 Microseconds.  
 Power coefficient: 0.001dB/W (change in attenuation with increase in power).  
 Temperature coefficient: 0.001dB/Deg. C max., 0.0003dB/Deg. C type.

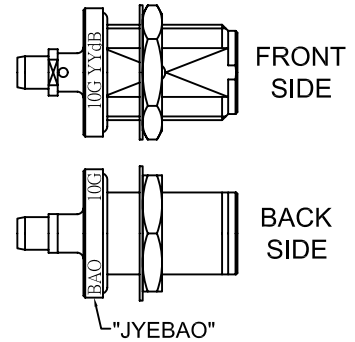

Attenuation	VSWR			Attenuation deviation (±dB)		
	DC~2GHz	2~5GHz	5~10GHz	DC~2GHz	2~5GHz	5~10GHz
3dB	≤1.15	≤1.25	≤1.35	±0.2dB	±0.4dB	±0.7dB

Parts	Material	Plating ( Micro-inch )
Hex Nut	Brass	Tin-Zinc-Copper-Alloy 100 Over Copper 50
Lock Washer	Brass	Tin-Zinc-Copper-Alloy 100 Over Copper 50
Gasket	Silicone	
Contact Pin	Beryllium Copper	Gold 4 Over Nickel-Phosphorus Alloy 80 Over Copper 20
Body	Brass	Tin-Zinc-Copper-Alloy 100 Over Copper 50

Weight: 37.19 g