

FAT-AM5N95T3G2W8

3GHz SMA Plug To N Reverse Polarity Jack Fixed Attenuator

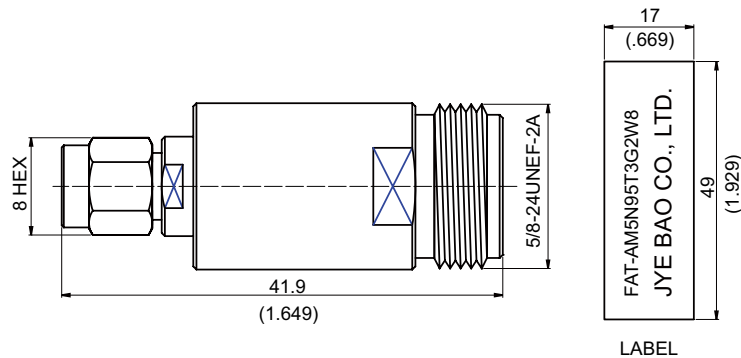

Nominal impedance: 50Ω±0.25Ω over operating temperature range.
 Operating temperature range: -50 degrees Celcius to +80 degrees Celcius.
 VSWR deviation: ±0.1% over operating temperature range.
 Power rating: 2W over operating temperature range.
 Power Rating (Peak): 100W for 25 Microseconds.
 Power Coefficient: 0.001dB/W (change in attenuation with increase in power).
 Temperature Coefficient: 0.001dB/Deg. C max., 0.0003dB/Deg.C typ.

Attenuation	VSWR		Attenuation deviation (+/-dB)	
	DC-2GHz	2-3GHz	DC-2GHz	2-3GHz
8dB	≤1.1	≤1.25	+/-0.2dB	+/-0.3dB

Parts	Material	Plating (Micro-inch)
Insulator	Teflon	
Contact Pin(SMA)	Phosphor Bronze	Gold 20 Over Nickel 50 Over Copper 50
Body	Brass	Tin-Zinc-Copper-Alloy 100 Over Copper 50
Renbrock Ring	Beryllium Copper	Tin-Zinc-Copper-Alloy 100 Over Copper 50
Gasket	Silicon	
Contact Pin(N)	Brass	Gold 20 Over Nickel 50 Over Copper 50
Coupling Nut	Brass	Tin-Zinc-Copper-Alloy 100 Over Copper 50

Weight:

This part number complies with RoHS.

Notice: JYEBAO reserves the right to make modifications deemed appropriate.