

FAT-AM5AF5G3G2W25

3GHz SMA Plug To SMA Jack Fixed Attenuator

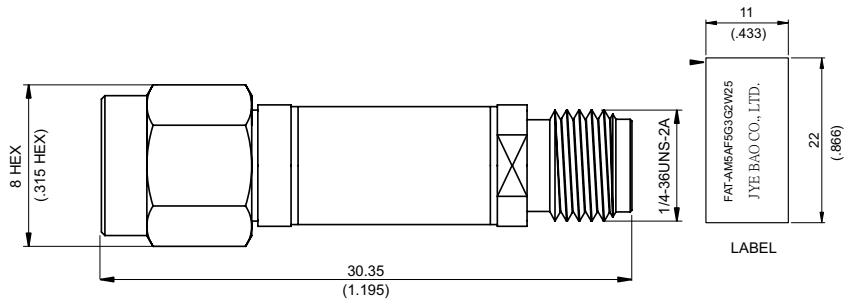

Nominal impedance: 50Ω±0.25Ω over operating temperature range.
 Operating temperature range: -50 degrees Celcius to +80 degrees Celcius.
 VSWR deviation: ±0.1% over operating temperature range.
 Power rating: 2W over operating temperature range.
 Power Rating (Peak): 100W for 25 Microseconds.
 Power Coefficient: 0.001dB/W (change in attenuation with increase in power).
 Temperature Coefficient: 0.001dB/Deg. C max., 0.0003dB/Deg.C typ.

Attenuation	VSWR		Attenuation deviation (+/-dB)	
	DC-2GHz	2-3GHz	DC-2GHz	2-3GHz
25dB	≤1.1	≤1.25	+/-0.4dB	+/-0.6dB

Parts	Material	Plating (Micro-inch)
Contact Pin	Beryllium Copper	Gold 10 Over Nickel 50 Over Copper 50
Body	Brass	Gold 5 Over Nickel 50 Over Copper 50
Gasket	Silicon	
Insulator	Teflon	
Coupling Nut	Brass	Gold 5 Over Nickel 50 Over Copper 50

Weight: 5.86 g

This part number complies with RoHS.

Notice: JYEBAO reserves the right to make modifications deemed appropriate.