

DC-AFNM0/5G50V50

SMA Jack To N Plug 50 Volt DC-Block

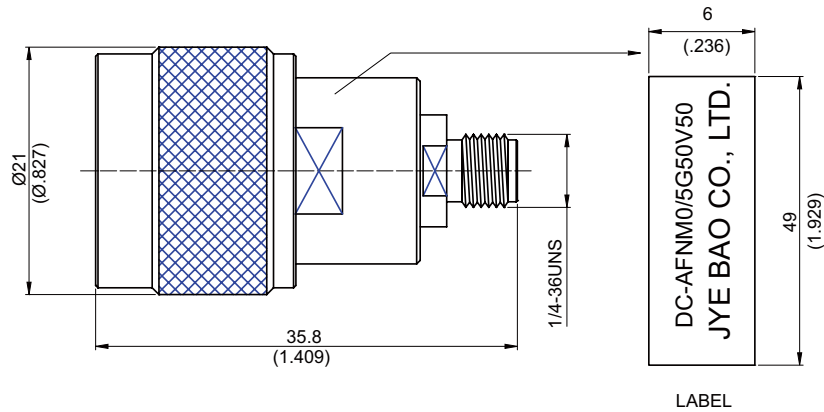

Connector 1		Connector 2		Frequency	Impedance	Voltage V	VSWR			Attenuation (dB)		
Series	Male/ Female	Series	Male/ Female				1G	3G	5G	1G	3G	5G
SMA	Female	N	Male	10 MHz to 5 GHz	50Ω	50V DC	≤1.12	≤1.2	≤1.32	≤0.1	≤0.2	≤0.5

Parts	Material	Plating (Micro-inch)
Body	Brass	Tin-Zinc-Copper-Alloy 100 Over Copper 50
Insulator	Teflon	
Contact Pin(SMA)	Beryllium Copper	Gold 20 Over Nickel 50 Over Copper 50
Retainer Ring	Brass	Tin-Zinc-Copper-Alloy 100 Over Copper 50
Gasket	Silicon	
Contact Pin(N)	Brass	Gold 20 Over Nickel 50 Over Copper 50
Coupling Nut	Brass	Tin-Zinc-Copper-Alloy 100 Over Copper 50

Weight:

This part number complies with RoHS.

Notice: JYEBAO reserves the right to make modifications deemed appropriate.