

NO.	COMPONENTS	IMPEDANCE
1	MCX FEMALE FOR BULKHEAD	50 OHM
2	RG316	50 OHM
3	HEAT SHRINKING TUBE	
4	MMCX MALE	50 OHM

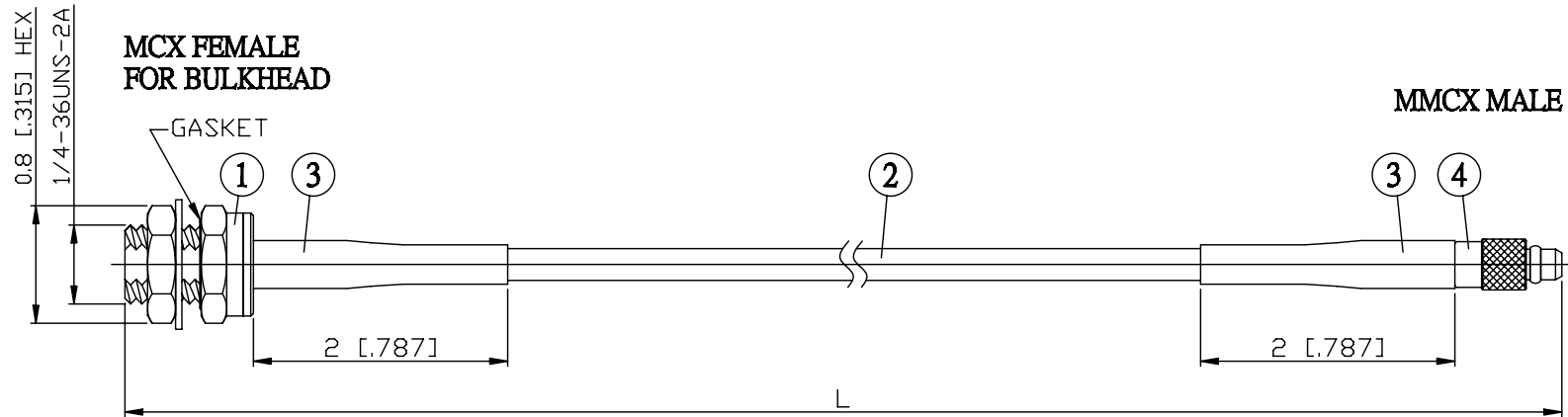

JYE BAO P/N	L CM (INCH)
D85E30-316-15	15 (5.906)
D85E30-316-30	30 (11.811)
D85E30-316-50	50 (19.685)
D85E30-316-100	100 (39.370)
D85E30-316-150	150 (59.055)
D85E30-316-200	200 (78.740)
D85E30-316-XXX	CUSTOM LENGTH IN CM

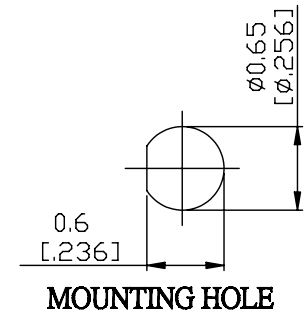

<b>LENGTH TOLERANCE IS ±1.5% OR ±10MM, WHICHEVER IS GREATER.</b>	<b>JYE BAO CO., LTD.</b> TAIPEI TAIWAN
	DESCRIPTION CABLE ASSEMBLY MCX JACK FOR BULKHEAD TO MMCX PLUG
	JYE BAO DRAWING NO. D85E30-316-XXX