

NO.	COMPONENTS	IMPEDANCE
1	MCX MALE	50 OHM
2	RG178	50 OHM
3	HEAT SHRINKING TUBE	
4	MMCX MALE RIGHT ANGLE	50 OHM

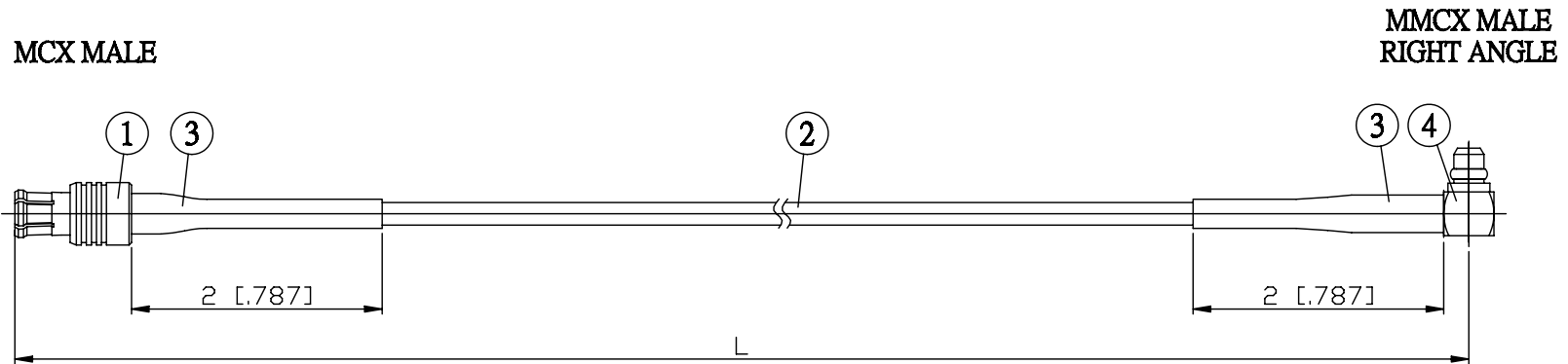

JYE BAO P/N	L CM (INCH)
D30E39-178-15	15 (5.906)
D30E39-178-30	30 (11.811)
D30E39-178-50	50 (19.685)
D30E39-178-100	100 (39.370)
D30E39-178-150	150 (59.055)
D30E39-178-200	200 (78.740)
D30E39-178-XXX	CUSTOM LENGTH IN CM

LENGTH TOLERANCE IS ±1.5% OR ±10MM, WHICHEVER IS GREATER.	JYE BAO CO., LTD. TAIPEI TAIWAN
	DESCRIPTION CABLE ASSEMBLY MCX PLUG TO MMCX PLUG R/A
	JYE BAO DRAWING NO. D30E39-178-XXX