

BMA3305ASG-0085

BMA Plug Solder Bulkhead For RG405  
18GHz VSWR 1.25

50Ω

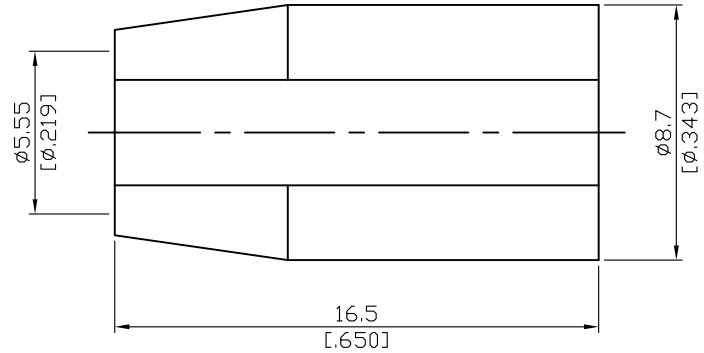
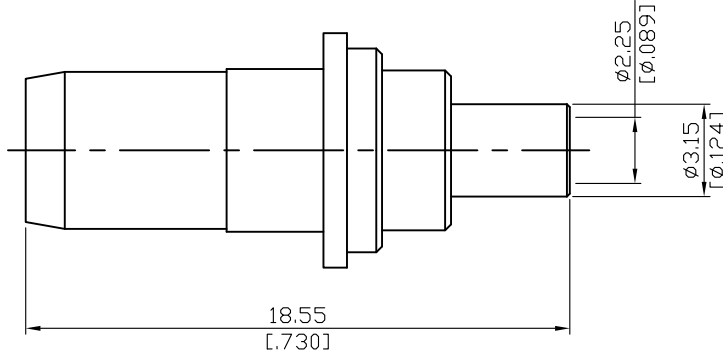

Parts	Material	Plating ( Micro-inch )
Tube	Bakelite	
Insulator	Teflon	
Contact Pin	Beryllium Copper	Gold 4 Over Nickel-Phosphorus Alloy 80 Over Copper 20
Body	Stainless Steel	Gold 5 over Nickel 50 over Copper 50

Suitable Cables: semi-rigid .085

This part number complies with RoHS.

Notice: JYEBAO reserves the right to make modifications deemed appropriate.

BMA	BMA3305ASG-0085																		
<div style="border: 1px solid black; padding: 2px; margin-bottom: 5px;">Interface</div> MIL-STD-348B																			
<div style="border: 1px solid black; padding: 2px; margin-bottom: 5px;">Electrical Data</div> <table style="width: 100%; border-collapse: collapse;"> <tr> <td style="width: 60%;">Impedance</td> <td>50Ω</td> </tr> <tr> <td>Frequency range</td> <td>DC to 18GHz</td> </tr> <tr> <td>VSWR</td> <td>≤ 1.2 (DC to 18GHz)</td> </tr> <tr> <td>Insertion loss</td> <td>≤ 0.03 x √f(GHz) dB</td> </tr> <tr> <td>Insulation resistance</td> <td>≥ 5000MΩ</td> </tr> <tr> <td>Contact resistance inner conductor</td> <td>≤ 2mΩ</td> </tr> <tr> <td>Contact resistance outer conductor</td> <td>≤ 2mΩ</td> </tr> <tr> <td>Dielectric withstanding voltage (at sea level)</td> <td>1000 V rms</td> </tr> <tr> <td>Working voltage (at sea level)</td> <td>670 V rms</td> </tr> </table>		Impedance	50Ω	Frequency range	DC to 18GHz	VSWR	≤ 1.2 (DC to 18GHz)	Insertion loss	≤ 0.03 x √f(GHz) dB	Insulation resistance	≥ 5000MΩ	Contact resistance inner conductor	≤ 2mΩ	Contact resistance outer conductor	≤ 2mΩ	Dielectric withstanding voltage (at sea level)	1000 V rms	Working voltage (at sea level)	670 V rms
Impedance	50Ω																		
Frequency range	DC to 18GHz																		
VSWR	≤ 1.2 (DC to 18GHz)																		
Insertion loss	≤ 0.03 x √f(GHz) dB																		
Insulation resistance	≥ 5000MΩ																		
Contact resistance inner conductor	≤ 2mΩ																		
Contact resistance outer conductor	≤ 2mΩ																		
Dielectric withstanding voltage (at sea level)	1000 V rms																		
Working voltage (at sea level)	670 V rms																		
<div style="border: 1px solid black; padding: 2px; margin-bottom: 5px;">Mechanical Data</div> <table style="width: 100%; border-collapse: collapse;"> <tr> <td style="width: 60%;">Engagement force</td> <td>≤ 3 lbs</td> </tr> <tr> <td>Disengagement force</td> <td>≤ 1.5 lbs</td> </tr> <tr> <td>Contact captivation-axial</td> <td>≤ 6.1 lbs</td> </tr> <tr> <td>Durability (mating)</td> <td>≥ 1000</td> </tr> </table>		Engagement force	≤ 3 lbs	Disengagement force	≤ 1.5 lbs	Contact captivation-axial	≤ 6.1 lbs	Durability (mating)	≥ 1000										
Engagement force	≤ 3 lbs																		
Disengagement force	≤ 1.5 lbs																		
Contact captivation-axial	≤ 6.1 lbs																		
Durability (mating)	≥ 1000																		
<div style="border: 1px solid black; padding: 2px; margin-bottom: 5px;">Environmental Data</div> <table style="width: 100%; border-collapse: collapse;"> <tr> <td style="width: 60%;">Temperature range</td> <td>-40°C to+165°C</td> </tr> <tr> <td>Thermal shock</td> <td>MIL-STD-202, Method 107, Condition B</td> </tr> <tr> <td>Moisture resistance</td> <td>MIL-STD-202, Method 106</td> </tr> <tr> <td>Corrosion</td> <td>MIL-STD-202, Method 101, Condition B</td> </tr> <tr> <td>RoHS</td> <td>Compliant</td> </tr> </table>		Temperature range	-40°C to+165°C	Thermal shock	MIL-STD-202, Method 107, Condition B	Moisture resistance	MIL-STD-202, Method 106	Corrosion	MIL-STD-202, Method 101, Condition B	RoHS	Compliant								
Temperature range	-40°C to+165°C																		
Thermal shock	MIL-STD-202, Method 107, Condition B																		
Moisture resistance	MIL-STD-202, Method 106																		
Corrosion	MIL-STD-202, Method 101, Condition B																		
RoHS	Compliant																		
<div style="border: 1px solid black; padding: 2px; margin-bottom: 5px;">Tooling</div> <table style="width: 100%; border-collapse: collapse;"> <tr> <td style="width: 60%;">Locator tool</td> <td>ST-011</td> </tr> <tr> <td>Soldering fixture</td> <td>ST-008</td> </tr> <tr> <td>Insert for .085 semi-rigid cable</td> <td>ST-009</td> </tr> </table>		Locator tool	ST-011	Soldering fixture	ST-008	Insert for .085 semi-rigid cable	ST-009												
Locator tool	ST-011																		
Soldering fixture	ST-008																		
Insert for .085 semi-rigid cable	ST-009																		

Notice: JYEBAO reserves the right to make modifications deemed appropriate.

# JYE BAO CO., LTD.

## CABLE ASSEMBLY INSTRUCTION

BMA3305ASG-0085	DATE	2020/04/24	REV	—
-----------------	------	------------	-----	---

A

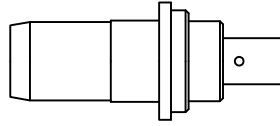

BODY

DIAGRAM	ASSEMBLY INSTRUCTION
---------	----------------------

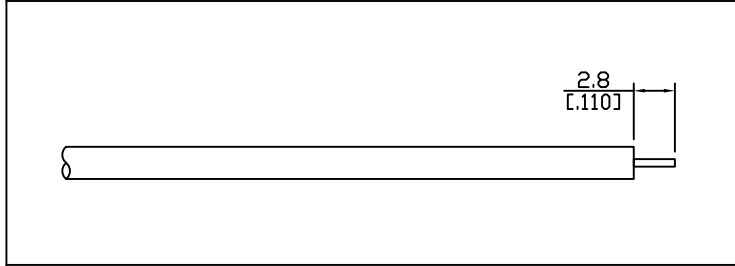

Step 1: STRIP AS SHOWN.

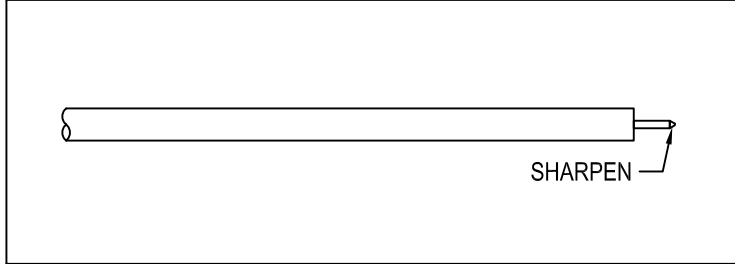

Step 2: SHARPEN CENTER CONDUCTOR TIP.

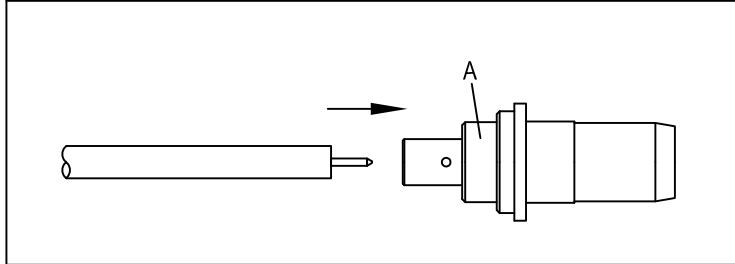

Step 3: SLIDE CABLE INTO CONNECTOR BODY "A".

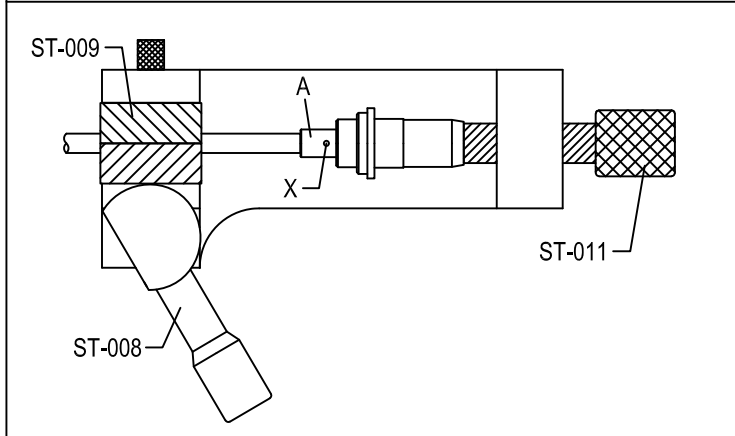

Step 4: USE SOLDERING FIXTURE " ST-008 ", INSERT TOOL " ST-009 " AND LOCATOR TOOL " ST-011 " TO FIX THE CONNECTOR. SOLDER IN " X " .

This part number complies with RoHS.

Notice: JYEBAO reserves the right to make modifications deemed appropriate.

APPROVED	CHECKED	DRAWING
----------	---------	---------

*Albert*

# BMA3305ASG-0085

