

NO.	COMPONENTS	IMPEDANCE
1	BNC FEMALE FOR BULKHEAD	50 OHM
2	JBY195	50 OHM
3	HEAT SHRINKING TUBE	
4	TNC REVERSE POLARITY MALE	50 OHM

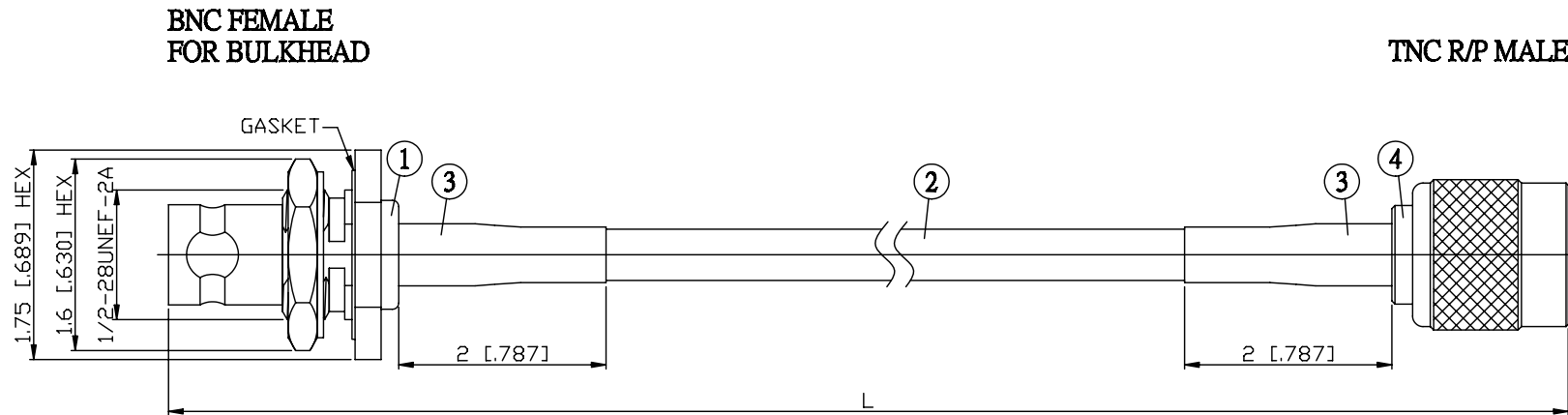

JYE BAO P/N	L CM (INCH)
B85T60-L195-15	15 (5.906)
B85T60-L195-30	30 (11.811)
B85T60-L195-50	50 (19.685)
B85T60-L195-100	100 (39.370)
B85T60-L195-150	150 (59.055)
B85T60-L195-200	200 (78.740)
B85T60-L195-XXX	CUSTOM LENGTH IN CM

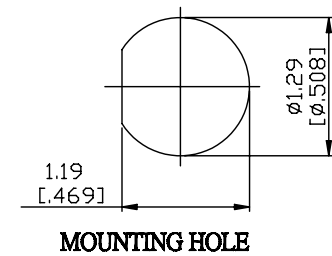

<b>LENGTH TOLERANCE IS ±1.5% OR ±10MM, WHICHEVER IS GREATER.</b>	<b>JYE BAO CO., LTD.</b> TAIPEI TAIWAN
	DESCRIPTION <b>CABLE ASSEMBLY BNC JACK FOR BULKHEAD TO TNC R/P PLUG</b>
	JYE BAO DRAWING NO. <b>B85T60-L195-XXX</b>