

NO.	COMPONENTS	IMPEDANCE
1	BNC FEMALE FOR BULKHEAD	50 OHM
2	RG174	50 OHM
3	HEAT SHRINKING TUBE	
4	TNC REVERSE POLARITY MALE	50 OHM

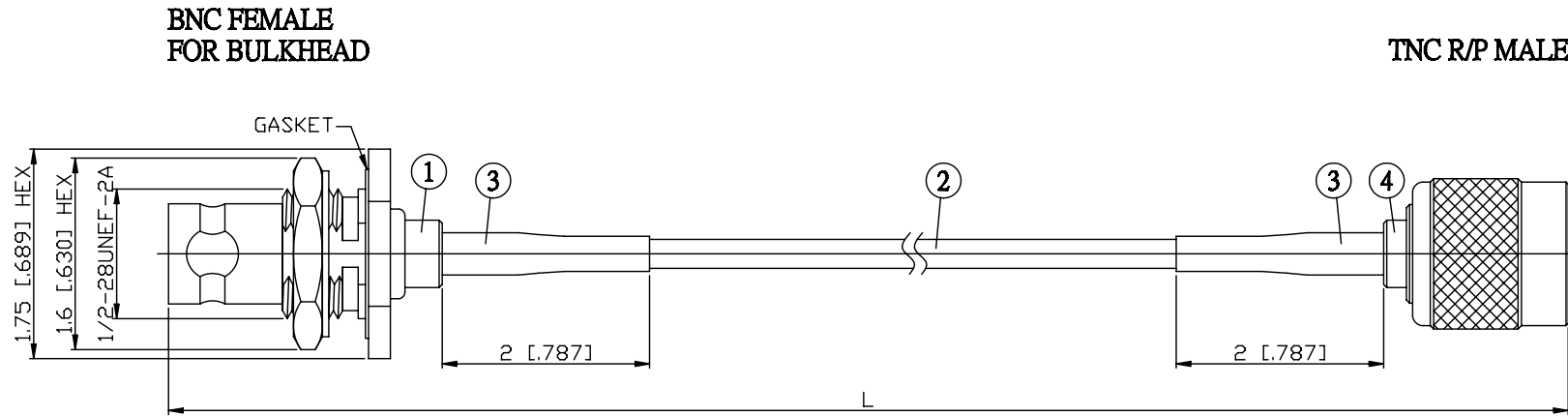

JYE BAO P/N	L CM (INCH)
B85T60-174-15	15 (5.906)
B85T60-174-30	30 (11.811)
B85T60-174-50	50 (19.685)
B85T60-174-100	100 (39.370)
B85T60-174-150	150 (59.055)
B85T60-174-200	200 (78.740)
B85T60-174-XXX	CUSTOM LENGTH IN CM

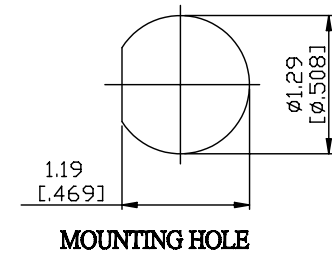

LENGTH TOLERANCE IS ±1.5% OR ±10MM, WHICHEVER IS GREATER.	JYE BAO CO., LTD. TAIPEI TAIWAN
	DESCRIPTION CABLE ASSEMBLY BNC JACK FOR BULKHEAD TO TNC R/P PLUG
	JYE BAO DRAWING NO. B85T60-174-XXX