

NO.	COMPONENTS	IMPEDANCE
1	BNC FEMALE	50 OHM
2	RG316	50 OHM
3	HEAT SHRINKING TUBE	
4	TNC FEMALE	50 OHM

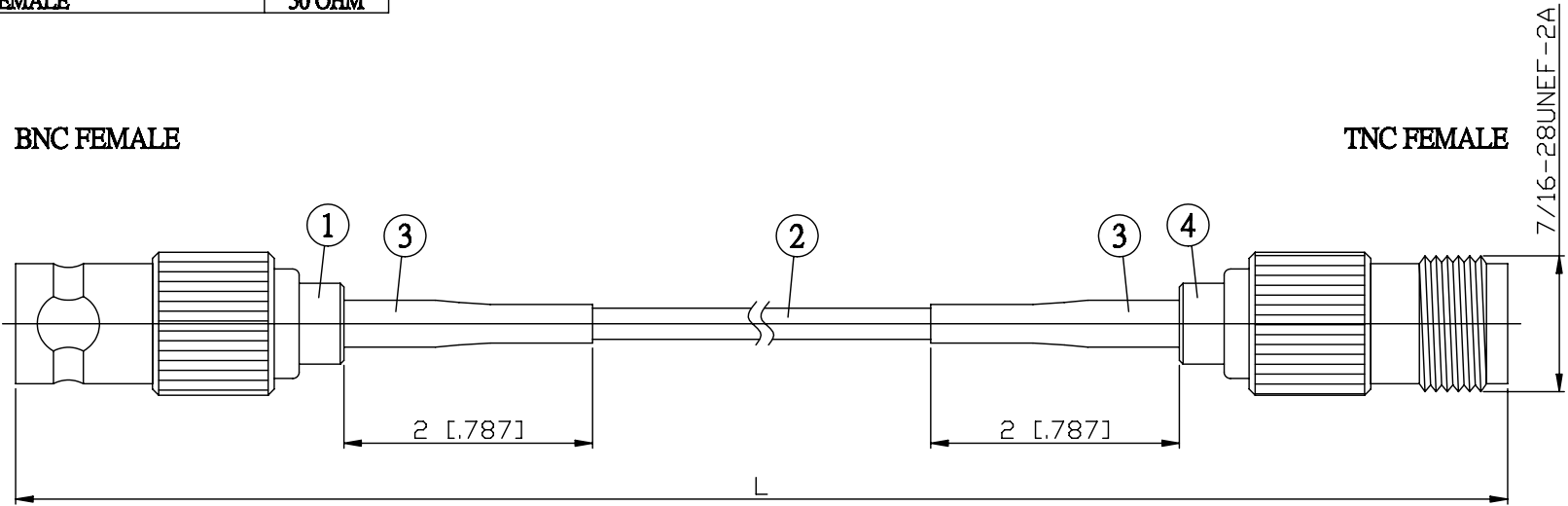

JYE BAO P/N	L CM (INCH)
B80T80-316-15	15 (5.906)
B80T80-316-30	30 (11.811)
B80T80-316-50	50 (19.685)
B80T80-316-100	100 (39.370)
B80T80-316-150	150 (59.055)
B80T80-316-200	200 (78.740)
B80T80-316-XXX	CUSTOM LENGTH IN CM

LENGTH TOLERANCE IS $\pm 1.5\%$ OR $\pm 10\text{MM}$, WHICHEVER IS GREATER.	JYE BAO CO., LTD. TAIPEI TAIWAN
	DESCRIPTION CABLE ASSEMBLY BNC JACK TO TNC JACK
	JYE BAO DRAWING NO. B80T80-316-XXX