

NO.	COMPONENTS	IMPEDANCE
1	BNC REVERSE POLARITY MALE	50 OHM
2	RG316	50 OHM
3	HEAT SHRINKING TUBE	
4	TNC FEMALE FOR BULKHEAD	50 OHM

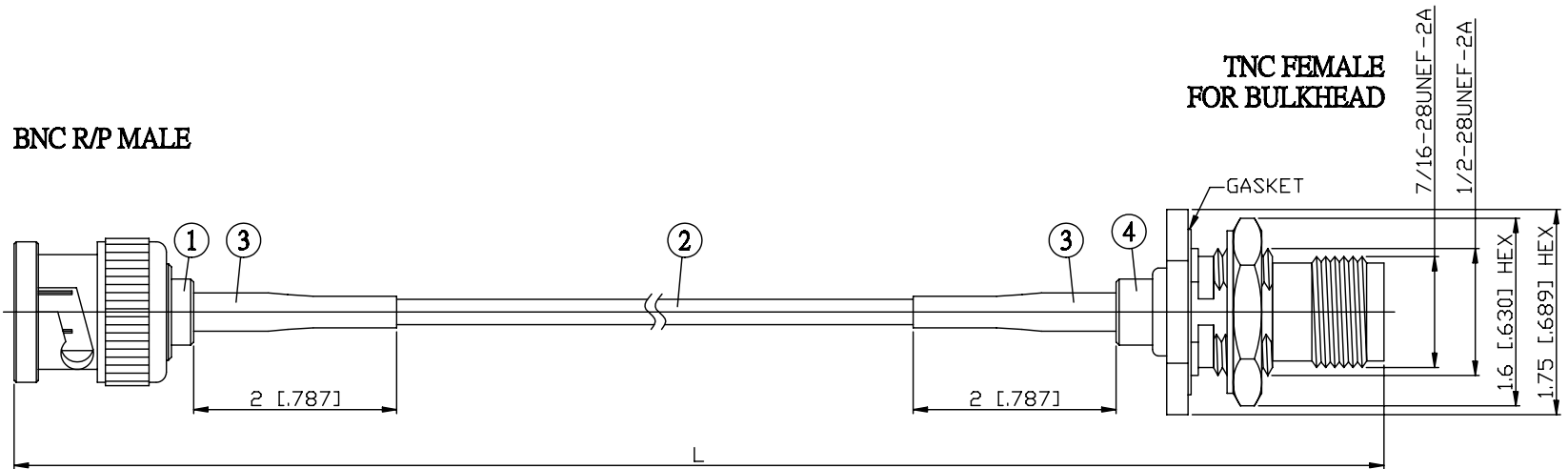

JYE BAO P/N	L CM (INCH)
B60T85-316-15	15 (5.906)
B60T85-316-30	30 (11.811)
B60T85-316-50	50 (19.685)
B60T85-316-100	100 (39.370)
B60T85-316-150	150 (59.055)
B60T85-316-200	200 (78.740)
B60T85-316-XXX	CUSTOM LENGTH IN CM

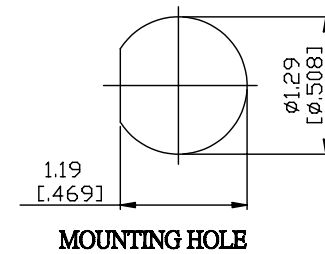

LENGTH TOLERANCE IS $\pm 1.5\%$ OR $\pm 10\text{MM}$, WHICHEVER IS GREATER.	JYE BAO CO., LTD. TAIPEI TAIWAN
	DESCRIPTION CABLE ASSEMBLY BNC R/P PLUG TO TNC JACK FOR BULKHEAD
	JYE BAO DRAWING NO. B60T85-316-XXX