

NO.	COMPONENTS	IMPEDANCE
1	BNC MALE RIGHT ANGLE	75 OHM
2	RG179	75 OHM
3	HEAT SHRINKING TUBE	
4	TNC MALE RIGHT ANGLE	75 OHM

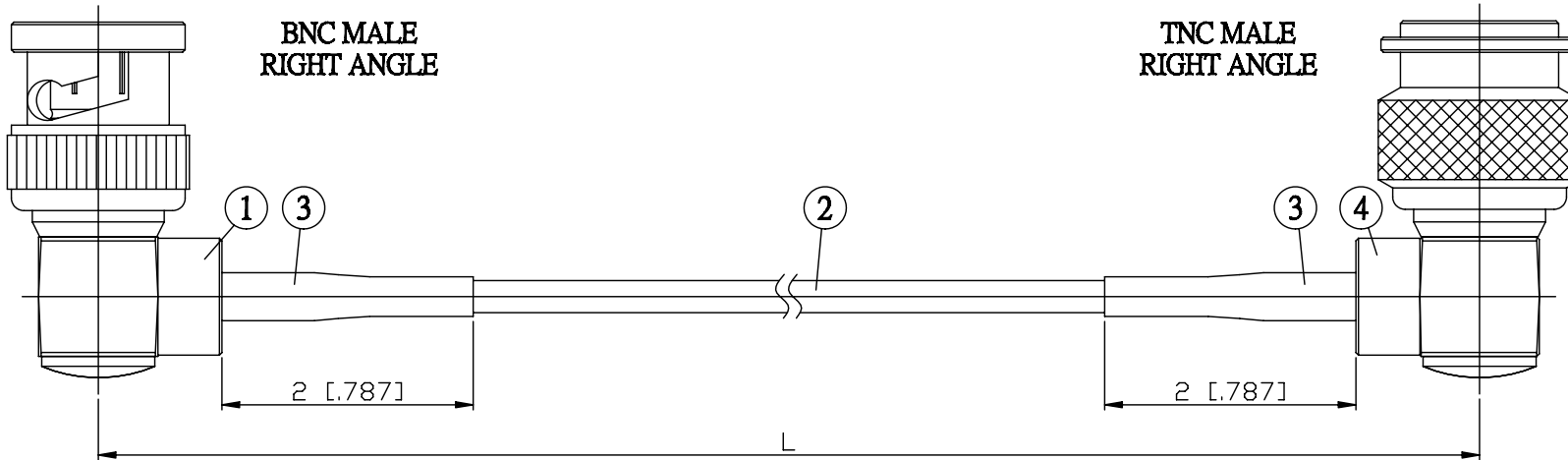

JYE BAO P/N	L CM (INCH)
B39T39-179-15	15 (5.906)
B39T39-179-30	30 (11.811)
B39T39-179-50	50 (19.685)
B39T39-179-100	100 (39.370)
B39T39-179-150	150 (59.055)
B39T39-179-200	200 (78.740)
B39T39-179-XXX	CUSTOM LENGTH IN CM

LENGTH TOLERANCE IS $\pm 1.5\%$ OR $\pm 10\text{MM}$, WHICHEVER IS GREATER.	JYE BAO CO., LTD. TAIPEI TAIWAN
	DESCRIPTION CABLE ASSEMBLY BNC PLUG R/A TO TNC PLUG R/A
	JYE BAO DRAWING NO. B39T39-179-XXX