

NO.	COMPONENTS	IMPEDANCE
1	BNC MALE RIGHT ANGLE	50 OHM
2	RG223	50 OHM
3	HEAT SHRINKING TUBE	
4	BNC FEMALE FOR BULKHEAD	50 OHM

BNC MALE
RIGHT ANGLE

BNC FEMALE
FOR BULKHEAD

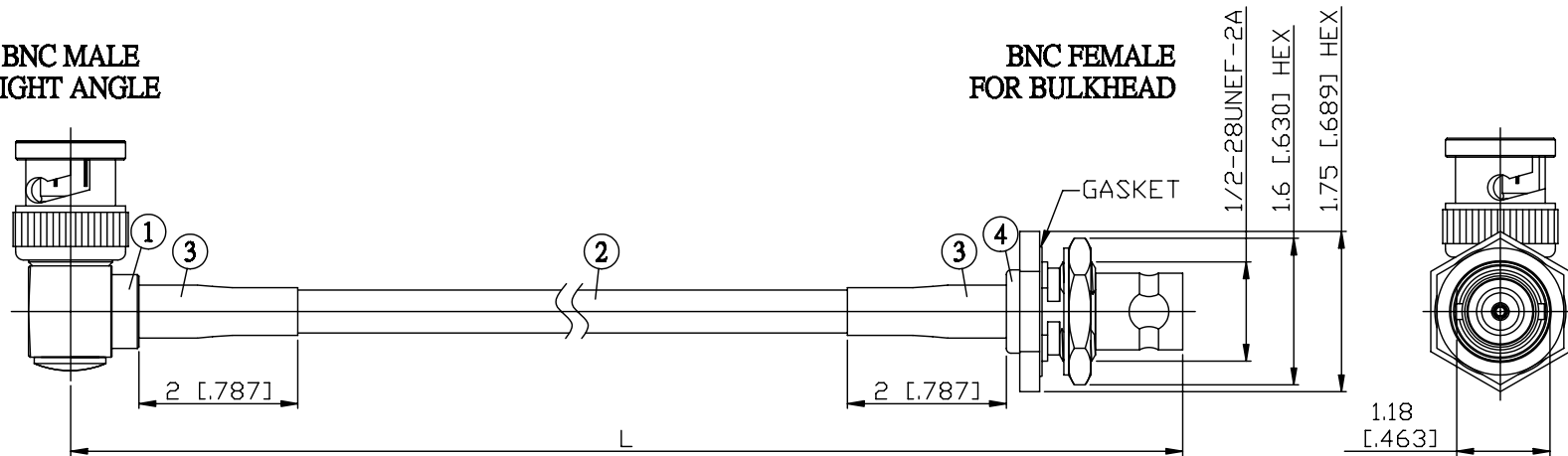

JYE BAO P/N	L CM (INCH)
B39B85-223-15	15 (5.906)
B39B85-223-30	30 (11.811)
B39B85-223-50	50 (19.685)
B39B85-223-100	100 (39.370)
B39B85-223-150	150 (59.055)
B39B85-223-200	200 (78.740)
B39B85-223-XXX	CUSTOM LENGTH IN CM

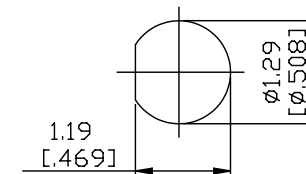

MOUNTING HOLE

LENGTH TOLERANCE IS $\pm 1.5\%$ OR $\pm 10\text{MM}$, WHICHEVER IS GREATER.	JYE BAO CO., LTD. TAIPEI TAIWAN
	DESCRIPTION CABLE ASSEMBLY BNC PLUG R/A TO BNC JACK FOR BULKHEAD
	JYE BAO DRAWING NO. B39B85-223-XXX