

ALS-K8-1.85/8-1.1

Mitered 2.92mm Jack To 1.85mm Jack
40GHz VSWR 1.1

50Ω

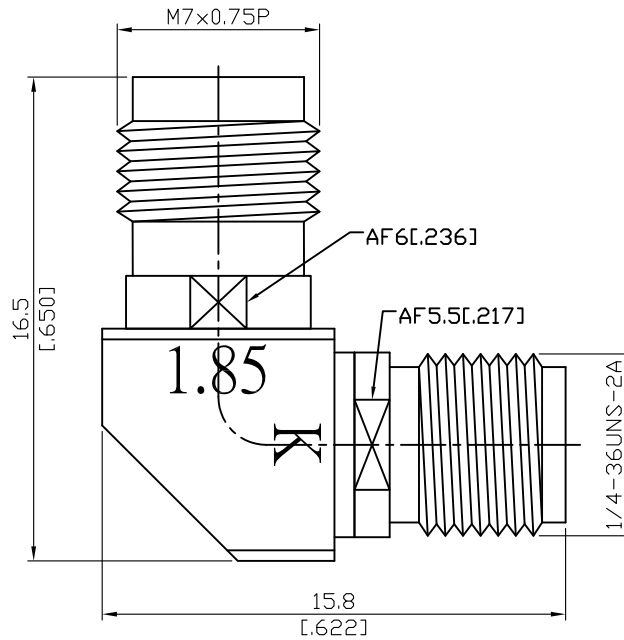

Parts	Material	Plating (Micro-inch)
Insulator	PPO	
Centre Contact	Beryllium Copper	Gold 4 Over Nickel-Phosphorus Alloy 80 Over Copper 20
Body	Stainless Steel	Passivated

--	--

This part number complies with RoHS.

Notice: JYEBAO reserves the right to make modifications deemed appropriate.

ALS-K8-1.85/8-1.1		Mitered 2.92mm Jack To 1.85mm Jack 40GHz VSWR 1.1	
Interface		1.85	2.92
Standard		IEEE287; IEC61169-32	MIL-STD-348B
Mechanically compatible with		2.4	SMA & 3.5
Electrical Data			
Impedance		50Ω	
Frequency Range		DC To 40GHz	
VSWR		≤ 1.1 (DC To 40GHz)	
Insertion Loss		≤ 0.06 x √f(GHz) dB	
Insulation Resistance		≥ 5000MΩ	
Dielectric Withstanding Voltage (at sea level)		500 V rms	
Working Voltage (at sea level)		150 V rms	
RF leakage		≥ 100dB to 1GHz	
Mechanical Data		1.85	2.92
Recommended Coupling Nut Torque		7.08 to 9.74 in-lbs	11.47 in-lbs
Coupling Proof Torque		15 in-lbs	15 in-lbs
Contact Captivation-axial		≥ 4.5 lbs	≥ 4.9 lbs
Durability (mating)		≥ 500	≥ 500
Environmental Data			
Temperature Range		-55°C to +105°C	
Thermal Shock		MIL-STD-202, Method 107, Condition B	
Moisture Resistance		MIL-STD-202, Method 206	
Corrosion		MIL-STD-202, Method 101, Condition B	
RoHS		Compliant	

ALS-K8-1.85/8-1.1

