

ALS-A3K3-27-1.1

Mitered SMA Plug To 2.92mm Plug
27GHz VSWR 1.1

50Ω

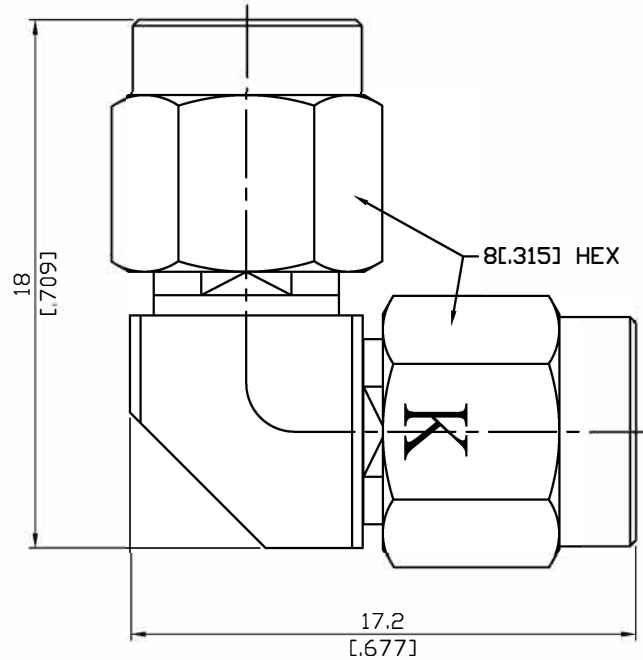

Parts	Material	Plating (Micro-inch)
Retainer Ring	Beryllium Copper	Tin-Zinc-Copper-Alloy 100 Over Copper 50
Gasket	Silicone	
Ferrule	Stainless Steel	Passivated
Contact Pin	Beryllium Copper	Gold 4 Over Nickel-Phosphorus Alloy 80 Over Copper 20
Insulator	PPO	
Insulator	Teflon	
Body	Stainless Steel	Passivated
Coupling Nut	Stainless Steel	Passivated

This part number complies with RoHS.

Notice: JYEBAO reserves the right to make modifications deemed appropriate.

ALS-A3K3-27-1.1		Mitered SMA Plug To 2.92mm Plug 27GHz VSWR 1.1	
Interface		2.92	SMA
Standard		MIL-STD-348B	MIL-STD-348B
Mechanically compatible with		3.5 & SMA	2.92 & 3.5
Electrical Data			
Impedance		50Ω	
Frequency Range		DC To 27GHz	
VSWR		≤ 1.1 (DC To 27GHz)	
Insertion Loss		≤ 0.07 x √f(GHz) dB	
Insulation Resistance		≥ 5000MΩ	
Dielectric Withstanding Voltage (at sea level)		750 V rms	
Working Voltage (at sea level)		250 V rms	
Mechanical Data		2.92	SMA
Recommended Coupling Nut Torque		11.47 in-lbs	7 to 9.5 in-lbs
Coupling Proof Torque		15 in-lbs	15 in-lbs
Contact Captivation-axial		≥ 4.9 lbs	≥ 6.1 lbs
Durability (mating)		≥ 500	≥ 500
Environmental Data			
Temperature Range		-55°C to +105°C	
Thermal Shock		MIL-STD-202, Method 107, Condition B	
Moisture Resistance		MIL-STD-202, Method 206	
Corrosion		MIL-STD-202, Method 101, Condition B	
RoHS		Compliant	

ALS-A3K3-27-1.1

