

ALS-A3A8-27-1.2

Mitered SMA Plug To SMA Jack
27GHz VSWR 1.2

50Ω

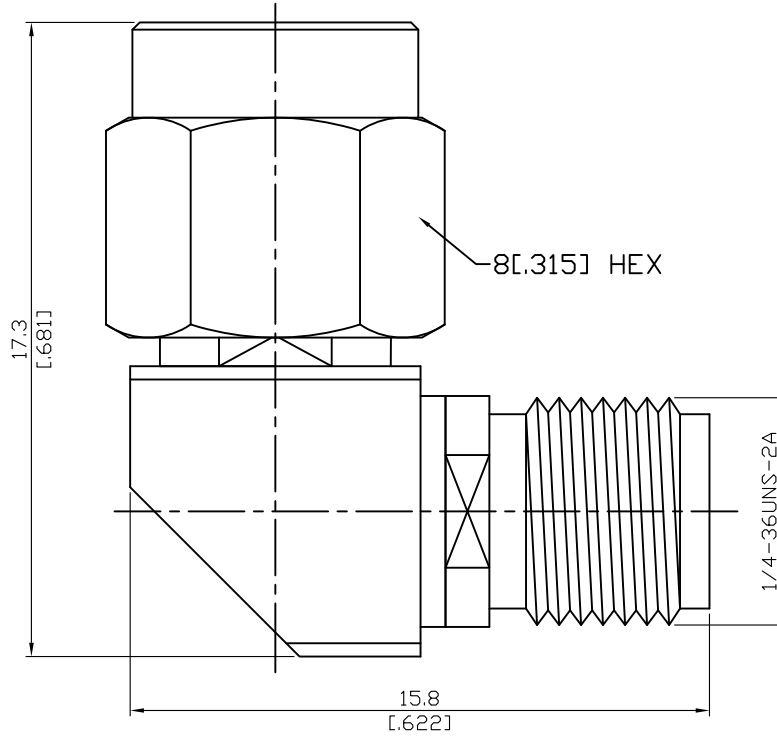

Parts	Material	Plating (Micro-inch)
Retainer Ring	Beryllium Copper	Tin-Zinc-Copper-Alloy 100 Over Copper 50
Gasket	Silicone	
Contact Pin	Beryllium Copper	Gold 4 Over Nickel-Phosphorus Alloy 80 Over Copper 20
Insulator	Teflon	
Body	Stainless Steel	Passivated
Coupling Nut	Stainless Steel	Passivated

This part number complies with RoHS.

Notice: JYEBAO reserves the right to make modifications deemed appropriate.

ALS-A3A8-27-1.2	Mitered SMA Plug To SMA Jack 27GHz VSWR 1.2																
<table border="0"> <tr> <td colspan="2" data-bbox="129 342 531 392">Interface</td> </tr> <tr> <td data-bbox="129 398 790 436">Standard</td> <td data-bbox="790 398 1481 436">MIL-STD-348B</td> </tr> <tr> <td data-bbox="129 443 790 481">Mechanically compatible with</td> <td data-bbox="790 443 1481 481">2.92 & 3.5</td> </tr> </table>		Interface		Standard	MIL-STD-348B	Mechanically compatible with	2.92 & 3.5										
Interface																	
Standard	MIL-STD-348B																
Mechanically compatible with	2.92 & 3.5																
<table border="0"> <tr> <td colspan="2" data-bbox="129 602 531 651">Electrical Data</td> </tr> <tr> <td data-bbox="129 658 790 696">Impedance</td> <td data-bbox="790 658 1481 696">50Ω</td> </tr> <tr> <td data-bbox="129 703 790 741">Frequency Range</td> <td data-bbox="790 703 1481 741">DC To 27GHz</td> </tr> <tr> <td data-bbox="129 748 790 786">VSWR</td> <td data-bbox="790 748 1481 786">≤ 1.2 (DC To 27GHz)</td> </tr> <tr> <td data-bbox="129 792 790 831">Insertion Loss</td> <td data-bbox="790 792 1481 831">≤ 0.06 x √f(GHz) dB</td> </tr> <tr> <td data-bbox="129 837 790 875">Insulation Resistance</td> <td data-bbox="790 837 1481 875">≥ 5000MΩ</td> </tr> <tr> <td data-bbox="129 882 790 920">Dielectric Withstanding Voltage (at sea level)</td> <td data-bbox="790 882 1481 920">1500 V rms</td> </tr> <tr> <td data-bbox="129 927 790 965">Working Voltage (at sea level)</td> <td data-bbox="790 927 1481 965">500 V rms</td> </tr> </table>		Electrical Data		Impedance	50Ω	Frequency Range	DC To 27GHz	VSWR	≤ 1.2 (DC To 27GHz)	Insertion Loss	≤ 0.06 x √f(GHz) dB	Insulation Resistance	≥ 5000MΩ	Dielectric Withstanding Voltage (at sea level)	1500 V rms	Working Voltage (at sea level)	500 V rms
Electrical Data																	
Impedance	50Ω																
Frequency Range	DC To 27GHz																
VSWR	≤ 1.2 (DC To 27GHz)																
Insertion Loss	≤ 0.06 x √f(GHz) dB																
Insulation Resistance	≥ 5000MΩ																
Dielectric Withstanding Voltage (at sea level)	1500 V rms																
Working Voltage (at sea level)	500 V rms																
<table border="0"> <tr> <td colspan="2" data-bbox="129 1099 531 1149">Mechanical Data</td> </tr> <tr> <td data-bbox="129 1155 790 1193">Recommended Coupling Nut Torque</td> <td data-bbox="790 1155 1481 1193">7 to 9.5 in-lbs</td> </tr> <tr> <td data-bbox="129 1200 790 1238">Coupling Proof Torque</td> <td data-bbox="790 1200 1481 1238">15 in-lbs</td> </tr> <tr> <td data-bbox="129 1245 790 1283">Coupling Nut Retention Force</td> <td data-bbox="790 1245 1481 1283">≥ 60.7 lbs</td> </tr> <tr> <td data-bbox="129 1290 790 1328">Contact Captivation-axial</td> <td data-bbox="790 1290 1481 1328">≥ 6.1 lbs</td> </tr> <tr> <td data-bbox="129 1335 790 1373">Durability (mating)</td> <td data-bbox="790 1335 1481 1373">≥ 500</td> </tr> </table>		Mechanical Data		Recommended Coupling Nut Torque	7 to 9.5 in-lbs	Coupling Proof Torque	15 in-lbs	Coupling Nut Retention Force	≥ 60.7 lbs	Contact Captivation-axial	≥ 6.1 lbs	Durability (mating)	≥ 500				
Mechanical Data																	
Recommended Coupling Nut Torque	7 to 9.5 in-lbs																
Coupling Proof Torque	15 in-lbs																
Coupling Nut Retention Force	≥ 60.7 lbs																
Contact Captivation-axial	≥ 6.1 lbs																
Durability (mating)	≥ 500																
<table border="0"> <tr> <td colspan="2" data-bbox="129 1503 531 1552">Environmental Data</td> </tr> <tr> <td data-bbox="129 1559 790 1597">Temperature Range</td> <td data-bbox="790 1559 1481 1597">-65°C to +165°C</td> </tr> <tr> <td data-bbox="129 1603 790 1641">Thermal Shock</td> <td data-bbox="790 1603 1481 1641">MIL-STD-202, Method 107, Condition B</td> </tr> <tr> <td data-bbox="129 1648 790 1686">Moisture Resistance</td> <td data-bbox="790 1648 1481 1686">MIL-STD-202, Method 206</td> </tr> <tr> <td data-bbox="129 1693 790 1731">Corrosion</td> <td data-bbox="790 1693 1481 1731">MIL-STD-202, Method 101, Condition B</td> </tr> <tr> <td data-bbox="129 1738 790 1776">RoHS</td> <td data-bbox="790 1738 1481 1776">Compliant</td> </tr> </table>		Environmental Data		Temperature Range	-65°C to +165°C	Thermal Shock	MIL-STD-202, Method 107, Condition B	Moisture Resistance	MIL-STD-202, Method 206	Corrosion	MIL-STD-202, Method 101, Condition B	RoHS	Compliant				
Environmental Data																	
Temperature Range	-65°C to +165°C																
Thermal Shock	MIL-STD-202, Method 107, Condition B																
Moisture Resistance	MIL-STD-202, Method 206																
Corrosion	MIL-STD-202, Method 101, Condition B																
RoHS	Compliant																

ALS-A3A8-27-1.2

