

ALS-1.85/8-2.4/3-1.3	Mitered 1.85mm Jack To 2.4mm Plug 50GHz VSWR 1.35	50Ω
----------------------	--	-----

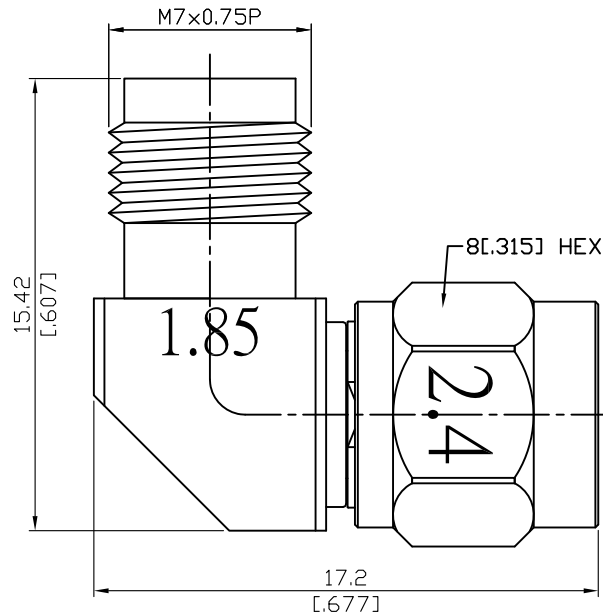

Parts	Material	Plating (Micro-inch)
Insulator	PPO	
Gasket	Silicone	
Centre Contact	Beryllium Copper	Gold 4 Over Nickel-Phosphorus Alloy 80 Over Copper 20
Retainer Ring	Beryllium Copper	Tin-Zinc-Copper-Alloy 100 Over Copper 50
Body	Stainless Steel	Passivated
Coupling Nut	Stainless Steel	Passivated

--	--

This part number complies with RoHS.

Notice: JYEBAO reserves the right to make modifications deemed appropriate.

ALS-1.85/8-2.4/3-1.3		Mitered 1.85mm Jack To 2.4mm Plug 50GHz VSWR 1.35	
Interface		1.85	2.4
Standard		IEEE287; IEC61169-32	MIL-STD-348B
Mechanically compatible with		2.4	1.85
Electrical Data			
Impedance		50Ω	
Frequency Range		DC To 50GHz	
VSWR		≤ 1.35 (DC To 50GHz)	
Insertion Loss		≤ 0.08 x √f(GHz) dB	
Insulation Resistance		≥ 5000MΩ	
Dielectric Withstanding Voltage (at sea level)		500 V rms	
Working Voltage (at sea level)		150 V rms	
RF leakage		≥ 100dB to 1GHz	
Mechanical Data			
Recommended Coupling Nut Torque		7.08 to 9.74 inch lbs	
Coupling Proof Torque		15 inch lbs	
Contact Captivation-axial		≥ 4.5 lbs	
Durability (mating)		≥ 500	
Environmental Data			
Temperature Range		-55°C to +105°C	
Thermal Shock		MIL-STD-202, Method 107, Condition B	
Moisture Resistance		MIL-STD-202, Method 206	
Corrosion		MIL-STD-202, Method 101, Condition B	
RoHS		Compliant	

Notice: JYEBAO reserves the right to make modifications deemed appropriate.

ALS-1.85/8-2.4/3-1.3

