

ADS-K8-1.85/8-1.1

2.92mm Jack To 1.85mm Jack  
40GHz VSWR 1.1

50Ω

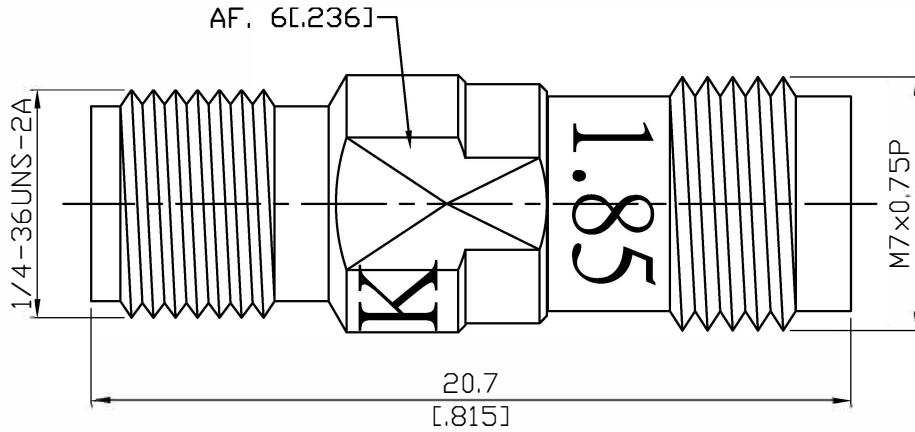

Parts	Material	Plating ( Micro-inch )
Contact Pin	Beryllium Copper	Gold 4 Over Nickel-Phosphorus Alloy 80 Over Copper 20
Insulator	PPO	
Body	Stainless Steel	Passivated

This part number complies with RoHS.

Notice: JYEBAO reserves the right to make modifications deemed appropriate.

ADS-K8-1.85/8-1.1	2.92mm Jack To 1.85mm Jack 40GHz VSWR 1.1																									
<div style="border: 1px solid black; padding: 2px; margin-bottom: 5px;">Interface</div> Standard Mechanically compatible with	<table border="1" style="width: 100%; border-collapse: collapse;"> <thead> <tr> <th style="width: 50%;"></th> <th style="width: 25%; text-align: center;">1.85</th> <th style="width: 25%; text-align: center;">2.92</th> </tr> </thead> <tbody> <tr> <td>Standard</td> <td style="text-align: center;">IEEE287; IEC61169-32</td> <td style="text-align: center;">MIL-STD-348B</td> </tr> <tr> <td>Mechanically compatible with</td> <td style="text-align: center;">2.4</td> <td style="text-align: center;">SMA &amp; 3.5</td> </tr> </tbody> </table>		1.85	2.92	Standard	IEEE287; IEC61169-32	MIL-STD-348B	Mechanically compatible with	2.4	SMA & 3.5																
	1.85	2.92																								
Standard	IEEE287; IEC61169-32	MIL-STD-348B																								
Mechanically compatible with	2.4	SMA & 3.5																								
<div style="border: 1px solid black; padding: 2px; margin-bottom: 5px;">Electrical Data</div> Impedance Frequency Range VSWR Insertion Loss Insulation Resistance Dielectric Withstanding Voltage (at sea level) Working Voltage (at sea level) RF leakage	<table style="width: 100%;"> <tbody> <tr> <td style="width: 50%;">Impedance</td> <td colspan="2" style="text-align: center;">50Ω</td> </tr> <tr> <td>Frequency Range</td> <td colspan="2" style="text-align: center;">DC To 40GHz</td> </tr> <tr> <td>VSWR</td> <td colspan="2" style="text-align: center;">≤ 1.1 (DC To 40GHz)</td> </tr> <tr> <td>Insertion Loss</td> <td colspan="2" style="text-align: center;">≤ 0.05 x √f(GHz) dB</td> </tr> <tr> <td>Insulation Resistance</td> <td colspan="2" style="text-align: center;">≥ 5000MΩ</td> </tr> <tr> <td>Dielectric Withstanding Voltage (at sea level)</td> <td colspan="2" style="text-align: center;">500 V rms</td> </tr> <tr> <td>Working Voltage (at sea level)</td> <td colspan="2" style="text-align: center;">150 V rms</td> </tr> <tr> <td>RF leakage</td> <td colspan="2" style="text-align: center;">≥ 100dB to 1GHz</td> </tr> </tbody> </table>		Impedance	50Ω		Frequency Range	DC To 40GHz		VSWR	≤ 1.1 (DC To 40GHz)		Insertion Loss	≤ 0.05 x √f(GHz) dB		Insulation Resistance	≥ 5000MΩ		Dielectric Withstanding Voltage (at sea level)	500 V rms		Working Voltage (at sea level)	150 V rms		RF leakage	≥ 100dB to 1GHz	
Impedance	50Ω																									
Frequency Range	DC To 40GHz																									
VSWR	≤ 1.1 (DC To 40GHz)																									
Insertion Loss	≤ 0.05 x √f(GHz) dB																									
Insulation Resistance	≥ 5000MΩ																									
Dielectric Withstanding Voltage (at sea level)	500 V rms																									
Working Voltage (at sea level)	150 V rms																									
RF leakage	≥ 100dB to 1GHz																									
<div style="border: 1px solid black; padding: 2px; margin-bottom: 5px;">Mechanical Data</div> Recommended Coupling Nut Torque Coupling Proof Torque Contact Captivation-axial Durability (mating)	<table border="1" style="width: 100%; border-collapse: collapse;"> <thead> <tr> <th style="width: 50%;"></th> <th style="width: 25%; text-align: center;">1.85</th> <th style="width: 25%; text-align: center;">2.92</th> </tr> </thead> <tbody> <tr> <td>Recommended Coupling Nut Torque</td> <td style="text-align: center;">7.08 to 9.74 in-lbs</td> <td style="text-align: center;">11.47 in-lbs</td> </tr> <tr> <td>Coupling Proof Torque</td> <td style="text-align: center;">15 in-lbs</td> <td style="text-align: center;">15 in-lbs</td> </tr> <tr> <td>Contact Captivation-axial</td> <td style="text-align: center;">≥ 4.5 lbs</td> <td style="text-align: center;">≥ 4.9 lbs</td> </tr> <tr> <td>Durability (mating)</td> <td style="text-align: center;">≥ 500</td> <td style="text-align: center;">≥ 500</td> </tr> </tbody> </table>			1.85	2.92	Recommended Coupling Nut Torque	7.08 to 9.74 in-lbs	11.47 in-lbs	Coupling Proof Torque	15 in-lbs	15 in-lbs	Contact Captivation-axial	≥ 4.5 lbs	≥ 4.9 lbs	Durability (mating)	≥ 500	≥ 500									
	1.85	2.92																								
Recommended Coupling Nut Torque	7.08 to 9.74 in-lbs	11.47 in-lbs																								
Coupling Proof Torque	15 in-lbs	15 in-lbs																								
Contact Captivation-axial	≥ 4.5 lbs	≥ 4.9 lbs																								
Durability (mating)	≥ 500	≥ 500																								
<div style="border: 1px solid black; padding: 2px; margin-bottom: 5px;">Environmental Data</div> Temperature Range Thermal Shock Moisture Resistance Corrosion RoHS	<table style="width: 100%;"> <tbody> <tr> <td style="width: 50%;">Temperature Range</td> <td colspan="2" style="text-align: center;">-55°C to +105°C</td> </tr> <tr> <td>Thermal Shock</td> <td colspan="2" style="text-align: center;">MIL-STD-202, Method 107, Condition B</td> </tr> <tr> <td>Moisture Resistance</td> <td colspan="2" style="text-align: center;">MIL-STD-202, Method 206</td> </tr> <tr> <td>Corrosion</td> <td colspan="2" style="text-align: center;">MIL-STD-202, Method 101, Condition B</td> </tr> <tr> <td>RoHS</td> <td colspan="2" style="text-align: center;">Compliant</td> </tr> </tbody> </table>		Temperature Range	-55°C to +105°C		Thermal Shock	MIL-STD-202, Method 107, Condition B		Moisture Resistance	MIL-STD-202, Method 206		Corrosion	MIL-STD-202, Method 101, Condition B		RoHS	Compliant										
Temperature Range	-55°C to +105°C																									
Thermal Shock	MIL-STD-202, Method 107, Condition B																									
Moisture Resistance	MIL-STD-202, Method 206																									
Corrosion	MIL-STD-202, Method 101, Condition B																									
RoHS	Compliant																									

# ADS-K8-1.85/8-1.1

