

ADS-2.4/8-2.4/8-BF-1.25

2.4mm Jack To 2.4mm Jack Bulkhead
50GHz VSWR 1.25

50Ω

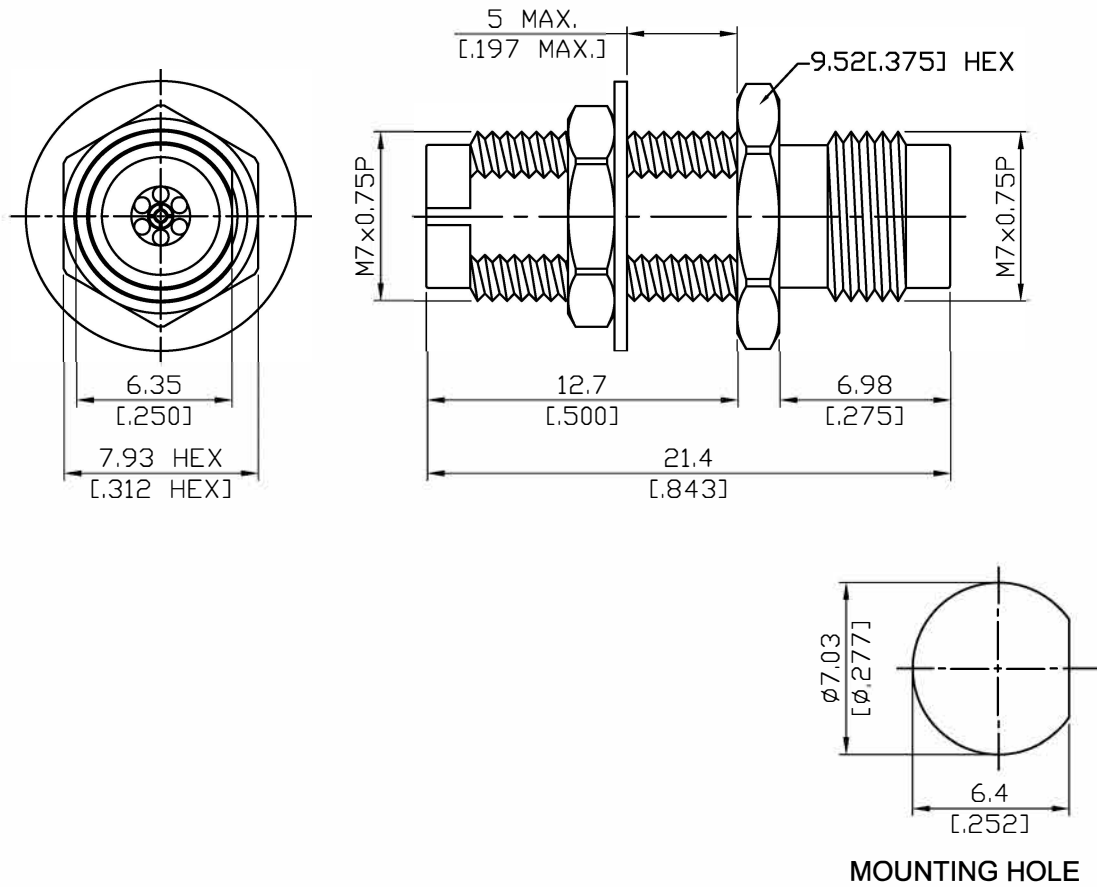

Parts	Material	Plating (Micro-inch)
Hex Nut	Stainless Steel	Passivated
Lock Washer	Stainless Steel	Passivated
Contact Pin	Beryllium Copper	Gold 4 Over Nickel-Phosphorus Alloy 80 Over Copper 20
Insulator	PPO	
Body	Stainless Steel	Passivated

This part number complies with RoHS.

Notice: JYEBAO reserves the right to make modifications deemed appropriate.

ADS-2.4/8-2.4/8-BF-1.25	2.4mm Jack To 2.4mm Jack Bulkhead 50GHz VSWR 1.25
Interface Standard MIL-STD-348B Mechanically compatible with 1.85	
Electrical Data Impedance 50Ω Frequency Range DC to 50GHz VSWR ≤ 1.25 (DC to 50GHz) Insertion Loss $\leq 0.04 \times \sqrt{f(\text{GHz})}$ dB Insulation Resistance $\geq 5000\text{M}\Omega$ Dielectric Withstanding Voltage (at sea level) 500 V rms Working Voltage (at sea level) 150 V rms RF Leakage $\geq 100\text{dB}$ to 1GHz	
Mechanical Data Recommended Coupling Nut Torque 7.08 to 9.74 inch lbs Coupling Proof Torque 15 inch lbs Contact Captivation-axial ≥ 4.5 lbs Durability (mating) ≥ 500	
Environmental Data Temperature Range -55°C to +105°C Thermal Shock MIL-STD-202, Method 107, Condition B Moisture Resistance MIL-STD-202, Method 206 Corrosion MIL-STD-202, Method 101, Condition B RoHS Compliant	

Notice: JYEBAO reserves the right to make modifications deemed appropriate.

ADS-2.4/8-2.4/8-BF-1.25

