

AD45S-T8T8-18-1.2

45° Angle TNC Jack to TNC Jack
18GHz VSWR 1.2

50Ω

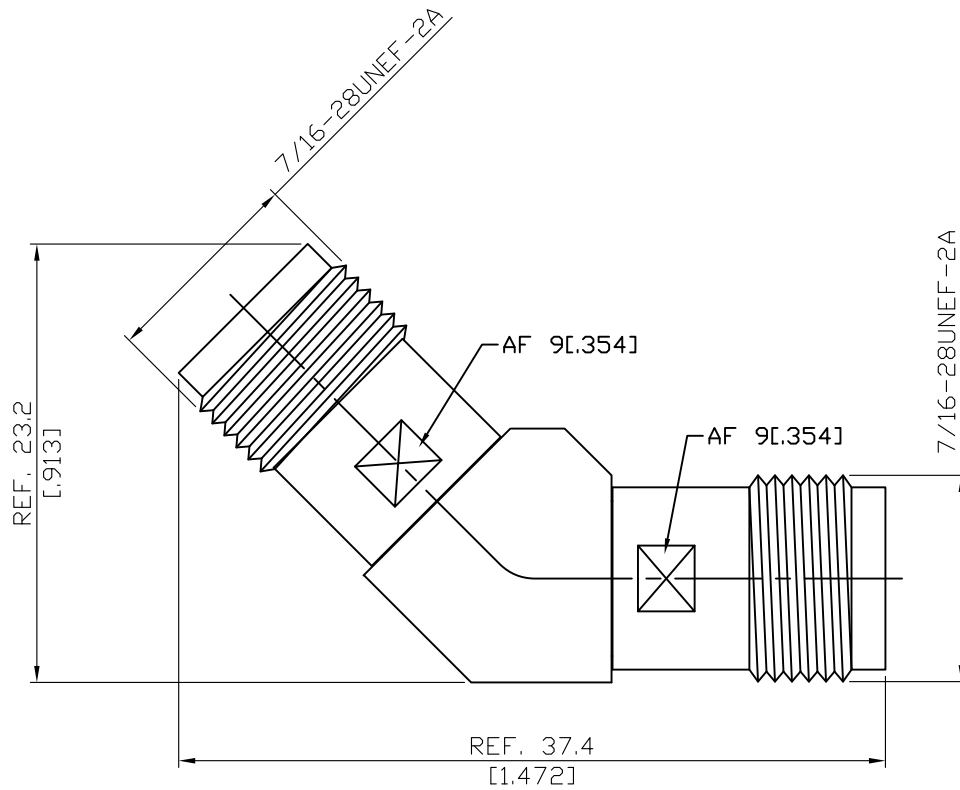

Parts	Material	Plating (Micro-inch)
Body	Stainless Steel	Passivated
Insulator	Teflon	
Contact Pin	Beryllium Copper	Gold 4 Over Nickel-Phosphorus Alloy 80 Over Copper 20

This part number complies with RoHS.

Notice: JYEBAO reserves the right to make modifications deemed appropriate.

AD45S-T8T8-18-1.2	45° Angle TNC Jack To TNC Jack 18GHz VSWR 1.2																
<table border="0"> <tr> <td data-bbox="129 342 531 394">Interface</td> <td></td> </tr> <tr> <td data-bbox="129 394 531 533">Standard</td> <td data-bbox="531 394 1481 533">MIL-STD-348B</td> </tr> </table>		Interface		Standard	MIL-STD-348B												
Interface																	
Standard	MIL-STD-348B																
<table border="0"> <tr> <td data-bbox="129 555 531 607">Electrical Data</td> <td></td> </tr> <tr> <td data-bbox="129 607 531 658">Impedance</td> <td data-bbox="531 607 1481 658">50Ω</td> </tr> <tr> <td data-bbox="129 658 531 710">Frequency Range</td> <td data-bbox="531 658 1481 710">DC to 18GHz</td> </tr> <tr> <td data-bbox="129 710 531 761">VSWR</td> <td data-bbox="531 710 1481 761">≤ 1.2 (DC To 18GHz)</td> </tr> <tr> <td data-bbox="129 761 531 813">Insertion Loss</td> <td data-bbox="531 761 1481 813">≤ 0.07 x √f(GHz) dB</td> </tr> <tr> <td data-bbox="129 813 531 864">Insulation Resistance</td> <td data-bbox="531 813 1481 864">≥ 5000MΩ</td> </tr> <tr> <td data-bbox="129 864 531 916">Dielectric Withstanding Voltage (at sea level)</td> <td data-bbox="531 864 1481 916">1500 V rms</td> </tr> <tr> <td data-bbox="129 916 531 967">Working Voltage (at sea level)</td> <td data-bbox="531 916 1481 967">500 V rms</td> </tr> </table>		Electrical Data		Impedance	50Ω	Frequency Range	DC to 18GHz	VSWR	≤ 1.2 (DC To 18GHz)	Insertion Loss	≤ 0.07 x √f(GHz) dB	Insulation Resistance	≥ 5000MΩ	Dielectric Withstanding Voltage (at sea level)	1500 V rms	Working Voltage (at sea level)	500 V rms
Electrical Data																	
Impedance	50Ω																
Frequency Range	DC to 18GHz																
VSWR	≤ 1.2 (DC To 18GHz)																
Insertion Loss	≤ 0.07 x √f(GHz) dB																
Insulation Resistance	≥ 5000MΩ																
Dielectric Withstanding Voltage (at sea level)	1500 V rms																
Working Voltage (at sea level)	500 V rms																
<table border="0"> <tr> <td data-bbox="129 1052 531 1104">Mechanical Data</td> <td></td> </tr> <tr> <td data-bbox="129 1104 531 1155">Recommended Coupling Nut Torque</td> <td data-bbox="531 1104 1481 1155">4.1 to 6.1 in-lbs</td> </tr> <tr> <td data-bbox="129 1155 531 1207">Coupling Proof Torque</td> <td data-bbox="531 1155 1481 1207">15 in-lbs</td> </tr> <tr> <td data-bbox="129 1207 531 1258">Contact Captivation-axial</td> <td data-bbox="531 1207 1481 1258">≥ 6.1 lbs</td> </tr> <tr> <td data-bbox="129 1258 531 1310">Durability (mating)</td> <td data-bbox="531 1258 1481 1310">≥ 500</td> </tr> </table>		Mechanical Data		Recommended Coupling Nut Torque	4.1 to 6.1 in-lbs	Coupling Proof Torque	15 in-lbs	Contact Captivation-axial	≥ 6.1 lbs	Durability (mating)	≥ 500						
Mechanical Data																	
Recommended Coupling Nut Torque	4.1 to 6.1 in-lbs																
Coupling Proof Torque	15 in-lbs																
Contact Captivation-axial	≥ 6.1 lbs																
Durability (mating)	≥ 500																
<table border="0"> <tr> <td data-bbox="129 1451 531 1503">Environmental Data</td> <td></td> </tr> <tr> <td data-bbox="129 1503 531 1554">Temperature Range</td> <td data-bbox="531 1503 1481 1554">-65°C to +165°C</td> </tr> <tr> <td data-bbox="129 1554 531 1606">Thermal Shock</td> <td data-bbox="531 1554 1481 1606">MIL-STD-202, Method 107, Condition B</td> </tr> <tr> <td data-bbox="129 1606 531 1657">Moisture Resistance</td> <td data-bbox="531 1606 1481 1657">MIL-STD-202, Method 206</td> </tr> <tr> <td data-bbox="129 1657 531 1709">Corrosion</td> <td data-bbox="531 1657 1481 1709">MIL-STD-202, Method 101, Condition B</td> </tr> <tr> <td data-bbox="129 1709 531 1760">RoHS</td> <td data-bbox="531 1709 1481 1760">Compliant</td> </tr> </table>		Environmental Data		Temperature Range	-65°C to +165°C	Thermal Shock	MIL-STD-202, Method 107, Condition B	Moisture Resistance	MIL-STD-202, Method 206	Corrosion	MIL-STD-202, Method 101, Condition B	RoHS	Compliant				
Environmental Data																	
Temperature Range	-65°C to +165°C																
Thermal Shock	MIL-STD-202, Method 107, Condition B																
Moisture Resistance	MIL-STD-202, Method 206																
Corrosion	MIL-STD-202, Method 101, Condition B																
RoHS	Compliant																

Notice: JYEBAO reserves the right to make modifications deemed appropriate.