

NO.	COMPONENTS	IMPEDANCE
1	SMA REVERSE POLARITY FEMALE FOR BULKHEAD	50 OHM
2	RG58	50 OHM
3	HEAT SHRINKING TUBE	
4	SMB MALE RIGHT ANGLE	50 OHM

REVISION			
REV.	DESCRIPTION	DATE	APPROVED
-	INITIAL RELEASE	2012/08/15	
A	修正SMA螺紋規格	2013/10/01	

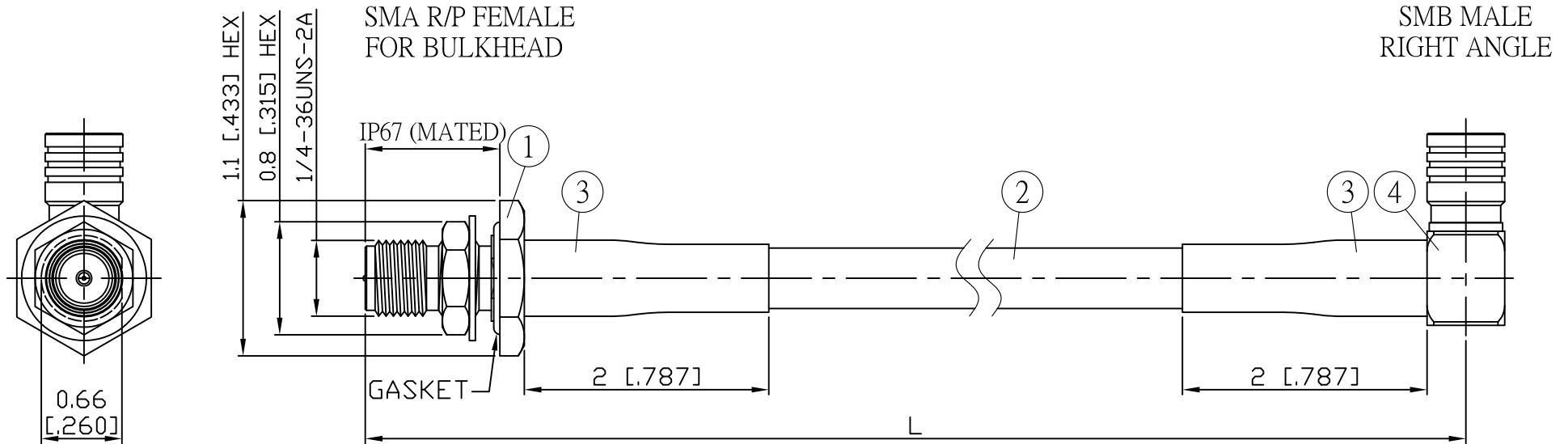

JYE BAO P/N	L CM (INCH)	L1 FT (MM)
A95S39-58-15	15 (5.906)	0.474 (144.5)
A95S39-58-30	30 (11.811)	0.966 (294.5)
A95S39-58-50	50 (19.685)	1.622 (494.5)
A95S39-58-100	100 (39.370)	3.263 (994.5)
A95S39-58-150	150 (59.055)	4.903 (1494.5)
A95S39-58-200	200 (78.740)	6.544 (1994.5)
A95S39-58-XXX	CUSTOM LENGTH IN CM	- - -

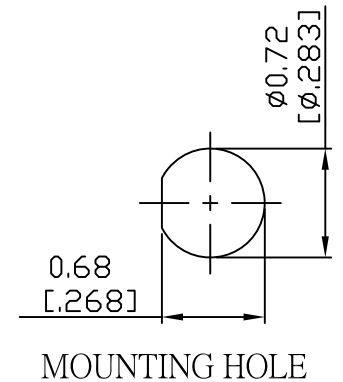

				STANDARD	REV A	UNIT CM(INCH)	JYE BAO CO., LTD.	
				APPROVED			TAIPEI TAIWAN	
				CHECKED		DATE	DESCRIPTION CABLE ASSEMBLY SMA R/P JACK FOR BULKHEAD TO SMB PLUG R/A	
				DRAWING	Albert	DATE	JYE BAO DRAWING NO. A95S39-58-XXX	
4	SMB3100-9058	SMB PLUG R/A	1	EA	LENGTH TOLERANCE IS ±1.5% OR ±10MM, WHICHEVER IS GREATER.			
3	G5(F)-8.0MM-BLACK	TUBE	0.04	M				
2	RG58	CABLE	L1 (SEE TABLE)	FT				
1	SMA9105-0058	SMA R/P JACK	1	EA				
NO.	PARTS NO.	DESCRIPTION	Q'TY	U/M				