

NO.	COMPONENTS	IMPEDANCE
1	SMA REVERSE POLARITY FEMALE FOR BULKHEAD	50 OHM
2	RG174	50 OHM
3	HEAT SHRINKING TUBE	
4	SMB MALE RIGHT ANGLE	50 OHM

REVISION			
REV.	DESCRIPTON	DATE	APPROVED
-	INITIAL RELEASE	2012/08/15	
A	修正SMA螺紋規格	2013/10/01	

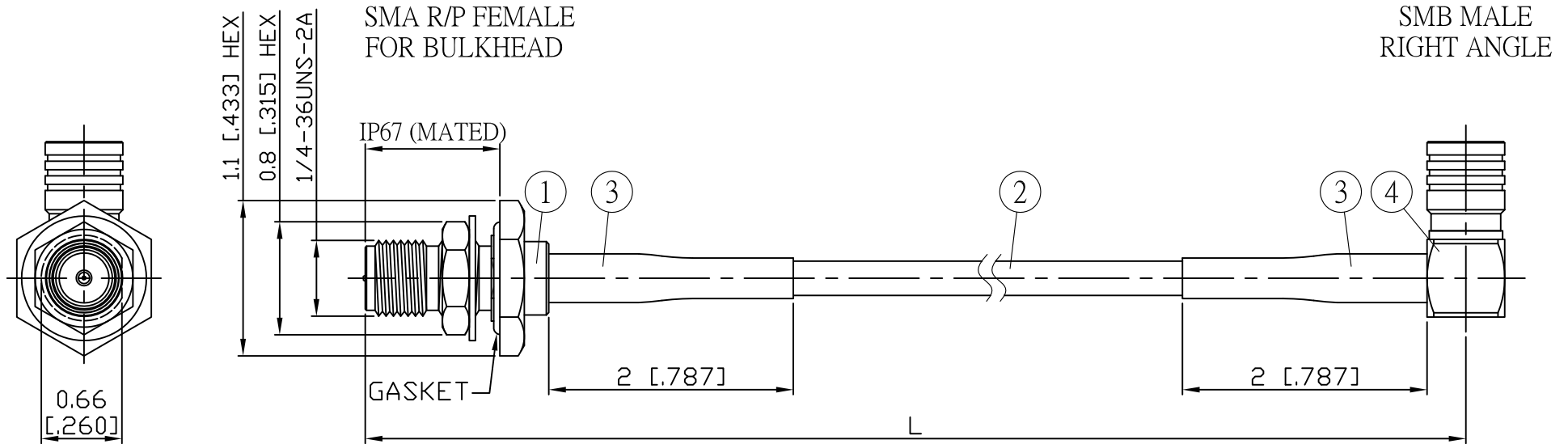

JYE BAO P/N	L CM (INCH)	L1 FT (MM)
A95S39-174-15	15 (5.906)	0.476 (145.0)
A95S39-174-30	30 (11.811)	0.968 (295.0)
A95S39-174-50	50 (19.685)	1.624 (495.0)
A95S39-174-100	100 (39.370)	3.264 (995.0)
A95S39-174-150	150 (59.055)	4.905 (1495.0)
A95S39-174-200	200 (78.740)	6.545 (1995.0)
A95S39-174-XXX	CUSTOM LENGTH IN CM	- - -

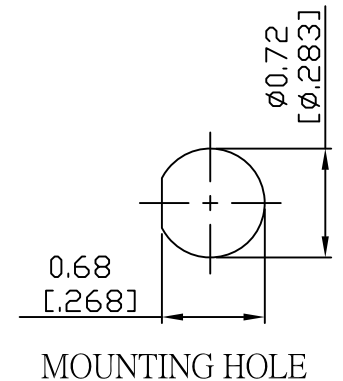

4	SMB3100-9316	SMB PLUG R/A	1	EA
3	G5(F)-4.0MM-BLACK	TUBE	0.04	M
2	RG174	CABLE	L1 (SEE TABLE)	FT
1	SMA9105-0316	SMA R/P JACK	1	EA
NO.	PARTS NO.	DESCRIPTION	Q'TY	U/M

LENGTH TOLERANCE IS $\pm 1.5\%$ OR $\pm 10\text{MM}$, WHICHEVER IS GREATER.	STANDARD	REV A	UNIT CM(INCH)	JYE BAO CO., LTD. TAIPEI TAIWAN
	APPROVED		DATE	
	CHECKED		DATE	
	DRAWING Albert		DATE	
DESCRIPTION CABLE ASSEMBLY SMA R/P JACK FOR BULKHEAD TO SMB PLUG R/A				JYE BAO DRAWING NO. A95S39-174-XXX