

NO.	COMPONENTS	IMPEDANCE
1	SMA REVERSE POLARITY FEMALE FOR BULKHEAD	50 OHM
2	RG316	50 OHM
3	HEAT SHRINKING TUBE	
4	N MALE	50 OHM

REVISION			
REV.	DESCRIPTION	DATE	APPROVED
-	INITIAL RELEASE	2012/08/15	
A	N3100-0316=>N3100B-0316 修正SMA螺紋規格	2013/05/23	

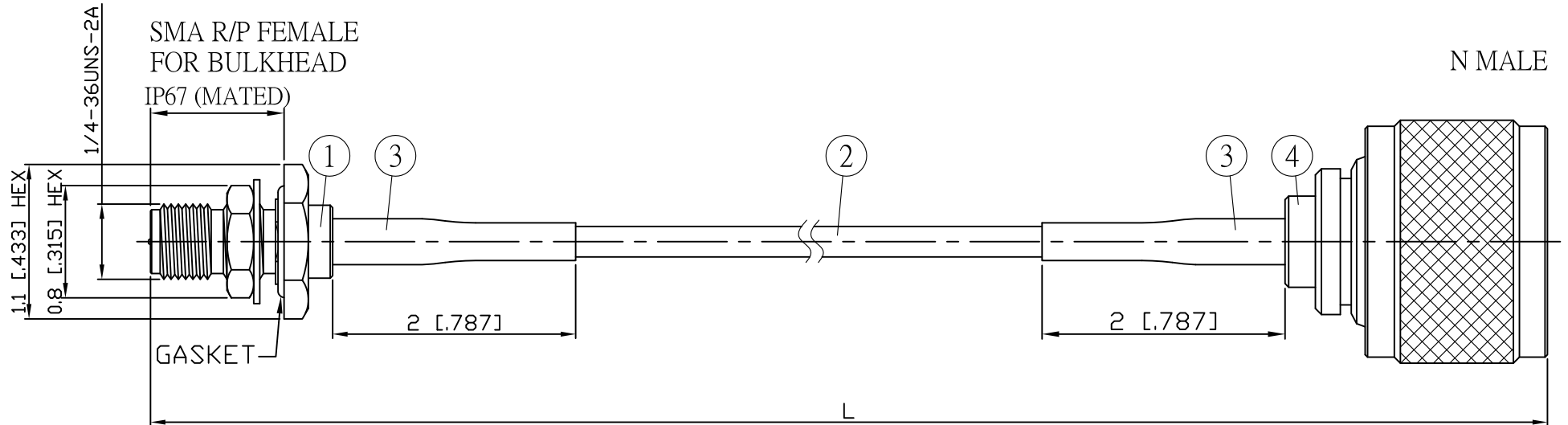

JYE BAO P/N	L CM (INCH)	L1 FT (MM)
A95N30-316-15	15 (5.906)	0.427 (130.0)
A95N30-316-30	30 (11.811)	0.919 (280.0)
A95N30-316-50	50 (19.685)	1.575 (480.0)
A95N30-316-100	100 (39.370)	3.215 (980.0)
A95N30-316-150	150 (59.055)	4.856 (1480.0)
A95N30-316-200	200 (78.740)	6.496 (1980.0)
A95N30-316-XXX	CUSTOM LENGTH IN CM	- - -

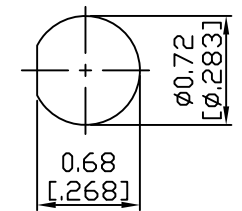

MOUNTING HOLE

					STANDARD	REV A	UNIT CM(INCH)	JYE BAO CO., LTD.	
					APPROVED			TAIPEI TAIWAN	
					CHECKED			DESCRIPTION	CABLE ASSEMBLY SMA R/P JACK FOR BULKHEAD TO N PLUG
					DRAWING	Albert		JYE BAO DRAWING NO.	A95N30-316-XXX
4	N3100B-0316	N PLUG	1	EA	LENGTH TOLERANCE IS ±1.5% OR ±10MM, WHICHEVER IS GREATER.				
3	G5(F)-4.0MM-BLACK	TUBE	0.04	M					
2	RG316	CABLE	L1 (SEE TABLE)	FT					
1	SMA9105-0316	SMA R/P JACK	1	EA					
NO.	PARTS NO.	DESCRIPTION	Q'TY	U/M					