

NO.	COMPONENTS	IMPEDANCE
1	SMA REVERSE POLARITY FEMALE FOR BULKHEAD	50 OHM
2	RG316	50 OHM
3	HEAT SHRINKING TUBE	
4	SMC MALE	50 OHM

REVISION			
REV.	DESCRIPTION	DATE	APPROVED
-	INITIAL RELEASE	2012/08/15	
A	修正SMA螺紋規格	2013/10/01	

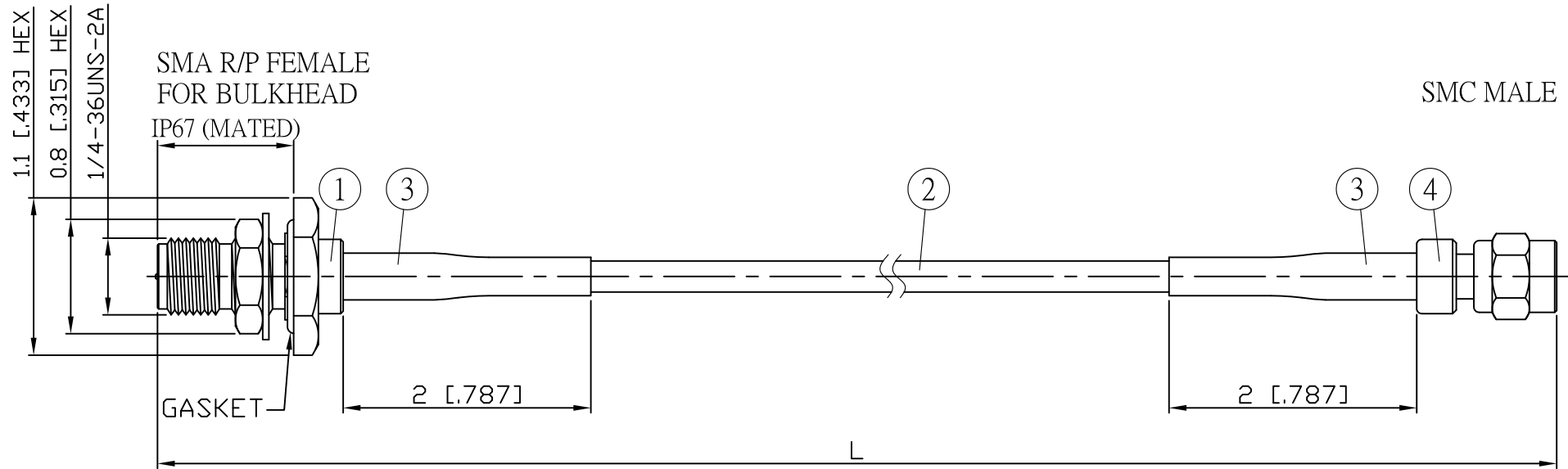

JYE BAO P/N	L CM (INCH)	L1 FT (MM)
A95MC30-316-15	15 (5.906)	0.451 (137.5)
A95MC30-316-30	30 (11.811)	0.943 (287.5)
A95MC30-316-50	50 (19.685)	1.599 (487.5)
A95MC30-316-100	100 (39.370)	3.240 (987.5)
A95MC30-316-150	150 (59.055)	4.880 (1487.5)
A95MC30-316-200	200 (78.740)	6.521 (1987.5)
A95MC30-316-XXX	CUSTOM LENGTH IN CM	- - -

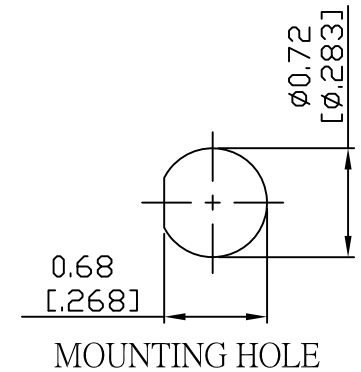

4	SMC3100-0316	SMC PLUG	1	EA
3	G5(F)-4.0MM-BLACK	TUBE	0.04	M
2	RG316	CABLE	L1 (SEE TABLE)	FT
1	SMA9105-0316	SMA R/P JACK	1	EA
NO.	PARTS NO.	DESCRIPTION	Q'TY	U/M

LENGTH TOLERANCE IS $\pm 1.5\%$ OR ± 10 MM, WHICHEVER IS GREATER.	STANDARD	REV A	UNIT CM(INCH)	JYE BAO CO., LTD. TAIPEI TAIWAN
	APPROVED	DATE	DESCRIPTION CABLE ASSEMBLY SMA R/P JACK FOR BULKHEAD TO SMC PLUG	
	CHECKED	DATE	JYE BAO DRAWING NO.	
	DRAWING Albert	DATE	A95MC30-316-XXX	