

NO.	COMPONENTS	IMPEDANCE
1	SMA REVERSE POLARITY FEMALE FOR BULKHEAD	50 OHM
2	RG178	50 OHM
3	HEAT SHRINKING TUBE	
4	MCX MALE RIGHT ANGLE	50 OHM

REVISION			
REV.	DESCRIPTON	DATE	APPROVED
-	INITIAL RELEASE	2012/08/15	
A	修正SMA螺紋規格	2013/10/01	

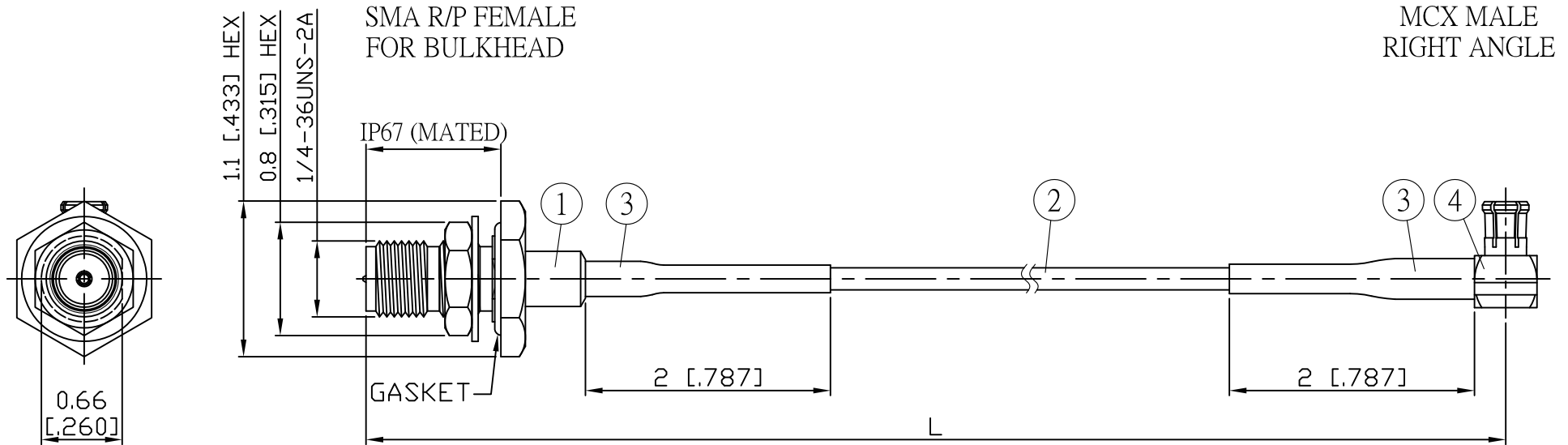

JYE BAO P/N	L CM (INCH)	L1 FT (MM)
A95D39-178-15	15 (5.906)	0.454 (138.5)
A95D39-178-30	30 (11.811)	0.947 (288.5)
A95D39-178-50	50 (19.685)	1.603 (488.5)
A95D39-178-100	100 (39.370)	3.243 (988.5)
A95D39-178-150	150 (59.055)	4.884 (1488.5)
A95D39-178-200	200 (78.740)	6.524 (1988.5)
A95D39-178-XXX	CUSTOM LENGTH IN CM	- - -

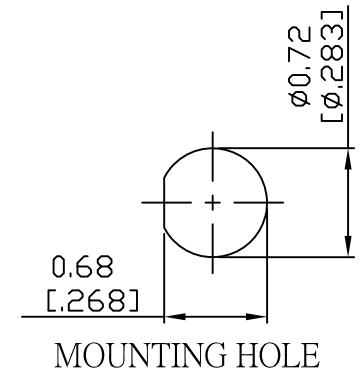

4	MCX3100-9178	MCX PLUG R/A	1	EA
3	G5(F)-3.0MM-BLACK	TUBE	0.04	M
2	RG178	CABLE	L1 (SEE TABLE)	FT
1	SMA9305-0178	SMA R/P JACK	1	EA
NO.	PARTS NO.	DESCRIPTION	Q'TY	U/M

LENGTH TOLERANCE IS $\pm 1.5\%$ OR ± 10 MM, WHICHEVER IS GREATER.	STANDARD	REV A	UNIT CM(INCH)	JYE BAO CO., LTD. TAIPEI TAIWAN
	APPROVED		DATE	
	CHECKED		DATE	
	DRAWING Albert		DATE	
DESCRIPTION CABLE ASSEMBLY SMA R/P JACK FOR BULKHEAD TO MCX PLUG R/A				JYE BAO DRAWING NO. A95D39-178-XXX