

NO.	COMPONENTS	IMPEDANCE
1	SMA REVERSE POLARITY FEMALE	50 OHM
2	.085" HANDBENDABLE CABLE (= JYEBAO P/N .085SRF-W-P-50)	50 OHM
3	BNC REVERSE POLARITY MALE	50 OHM

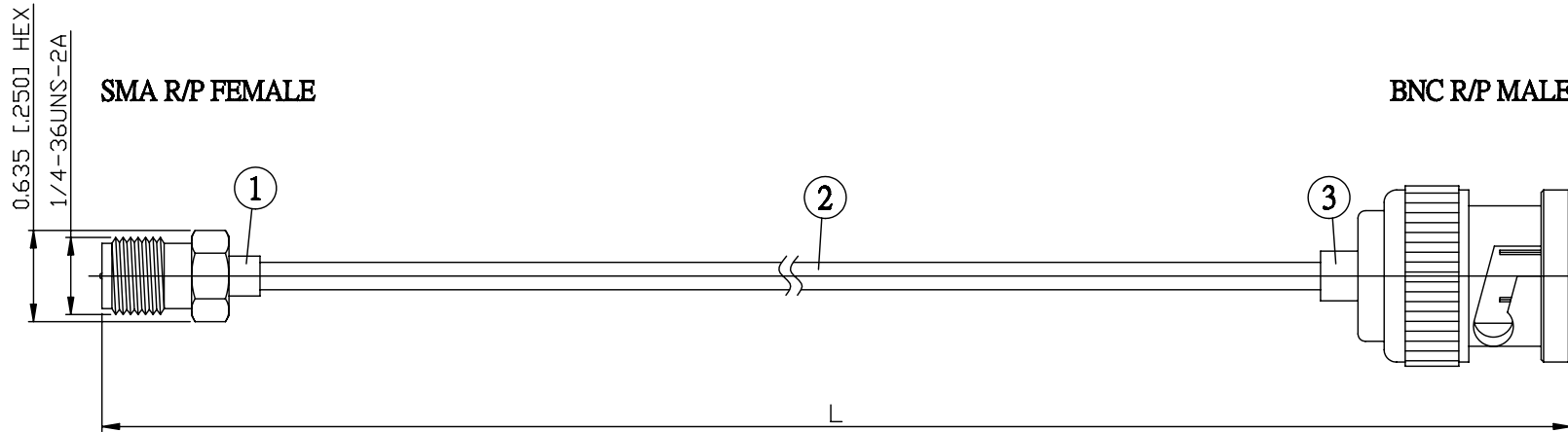

JYE BAO P/N	L CM (INCH)
A90B60-85S-15	15 (5.906)
A90B60-85S-30	30 (11.811)
A90B60-85S-50	50 (19.685)
A90B60-85S-100	100 (39.370)
A90B60-85S-150	150 (59.055)
A90B60-85S-200	200 (78.740)
A90B60-85S-XXX	CUSTOM LENGTH IN CM

LENGTH TOLERANCE IS $\pm 1.5\%$ OR $\pm 10\text{MM}$, WHICHEVER IS GREATER.	JYE BAO CO., LTD. TAIPEI TAIWAN
	DESCRIPTION CABLE ASSEMBLY SMA R/P JACK TO BNC R/P PLUG
	JYE BAO DRAWING NO. A90B60-85S-XXX