

NO.	COMPONENTS	IMPEDANCE
1	SMA FEMALE FOR BULKHEAD	50 OHM
2	RG58	50 OHM
3	HEAT SHRINKING TUBE	
4	TNC REVERSE POLARITY MALE	50 OHM

REVISION			
REV.	DESCRIPTON	DATE	APPROVED
-	INITIAL RELEASE	2012/08/15	
A	修正SMA螺紋規格	2013/10/01	

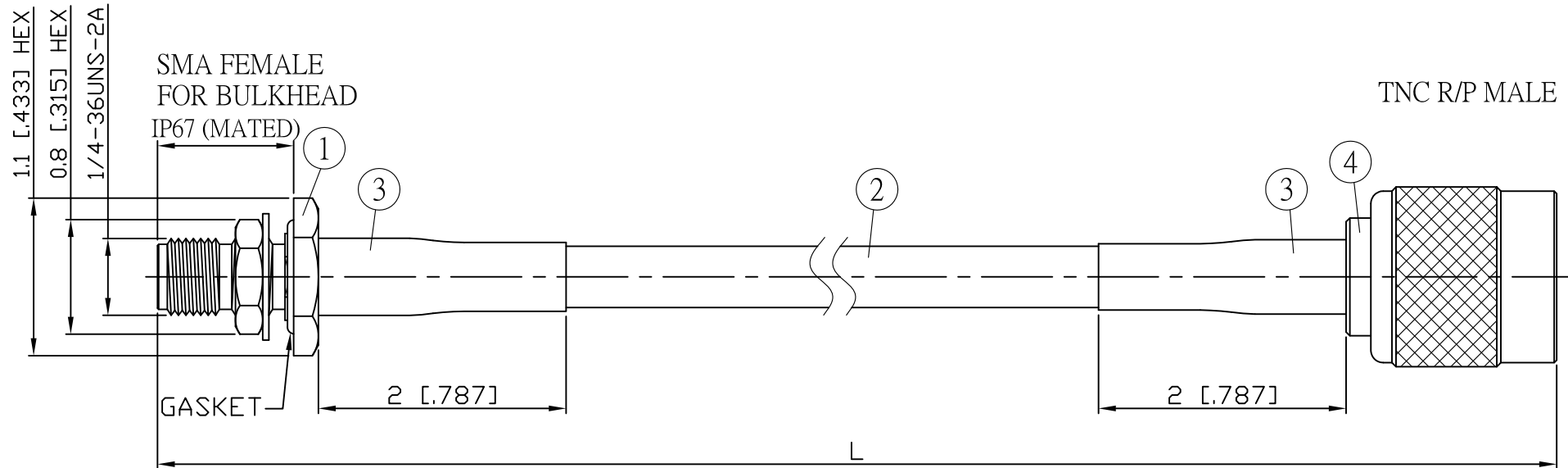

JYE BAO P/N	L CM (INCH)	L1 FT (MM)
A85T60-58-15	15 (5.906)	0.440 (134.0)
A85T60-58-30	30 (11.811)	0.932 (284.0)
A85T60-58-50	50 (19.685)	1.588 (484.0)
A85T60-58-100	100 (39.370)	3.228 (984.0)
A85T60-58-150	150 (59.055)	4.869 (1484.0)
A85T60-58-200	200 (78.740)	6.509 (1984.0)
A85T60-58-XXX	CUSTOM LENGTH IN CM	- - -

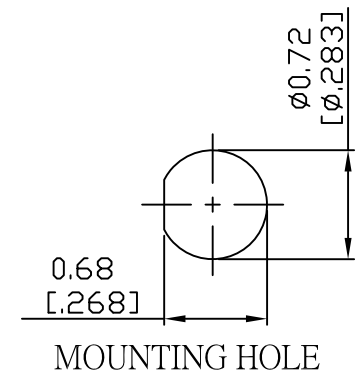

4	TNC6100-0058	TNC R/P PLUG	1	EA
3	G5(F)-8.0MM-BLACK	TUBE	0.04	M
2	RG58	CABLE	L1 (SEE TABLE)	FT
1	SMA8105-0058	SMA JACK	1	EA
NO.	PARTS NO.	DESCRIPTION	Q'TY	U/M

LENGTH TOLERANCE IS $\pm 1.5\%$ OR ± 10 MM, WHICHEVER IS GREATER.	STANDARD	REV A	UNIT CM(INCH)	JYE BAO CO., LTD. TAIPEI TAIWAN
	APPROVED		DATE	
	CHECKED		DATE	DESCRIPTION CABLE ASSEMBLY SMA JACK FOR BULKHEAD TO TNC R/P PLUG
	DRAWING Albert		DATE	JYE BAO DRAWING NO. A85T60-58-XXX