

NO.	COMPONENTS	IMPEDANCE
1	SMA FEMALE FOR BULKHEAD	50 OHM
2	RG223	50 OHM
3	HEAT SHRINKING TUBE	
4	TNC MALE	50 OHM

REVISION			
REV.	DESCRIPTION	DATE	APPROVED
-	INITIAL RELEASE	2012/08/15	
A	修正SMA螺紋規格	2013/10/01	

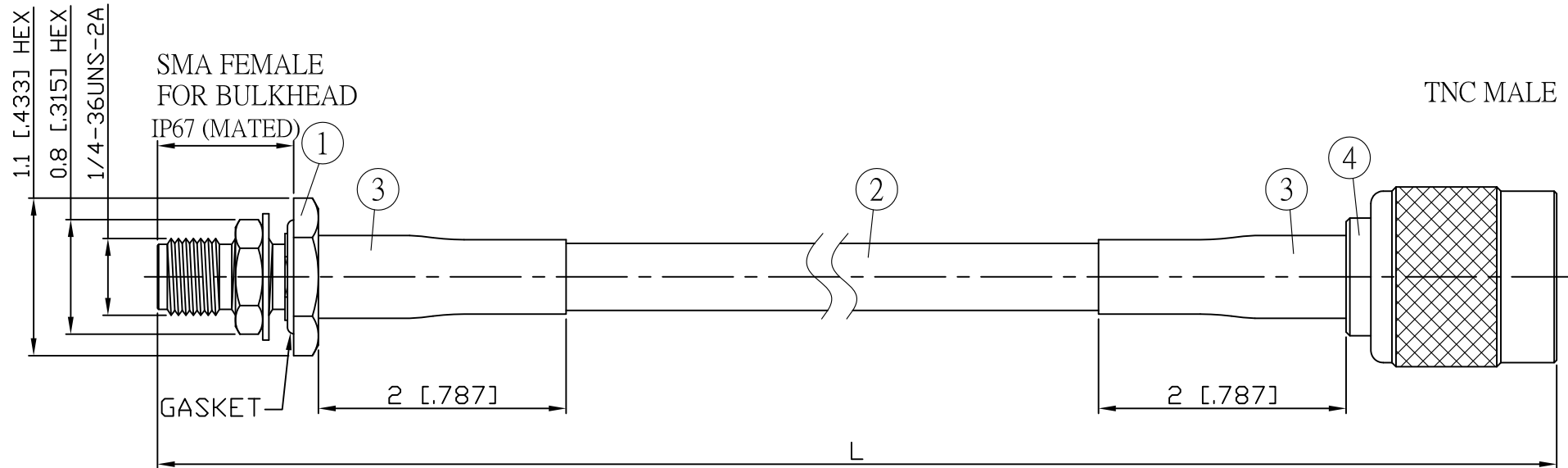

JYE BAO P/N	L CM (INCH)	L1 FT (MM)
A85T30-223-15	15 (5.906)	0.445 (135.5)
A85T30-223-30	30 (11.811)	0.937 (285.5)
A85T30-223-50	50 (19.685)	1.593 (485.5)
A85T30-223-100	100 (39.370)	3.233 (985.5)
A85T30-223-150	150 (59.055)	4.874 (1485.5)
A85T30-223-200	200 (78.740)	6.514 (1985.5)
A85T30-223-XXX	CUSTOM LENGTH IN CM	- - -

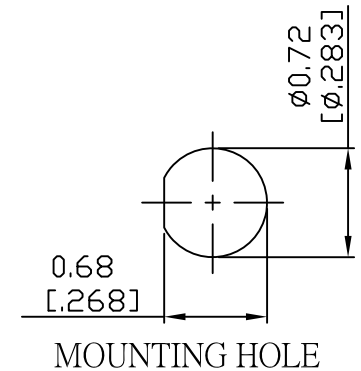

4	TNC3100-0223	TNC PLUG	1	EA
3	G5(F)-8.0MM-BLACK	TUBE	0.04	M
2	RG223	CABLE	L1 (SEE TABLE)	FT
1	SMA8105-0223	SMA JACK	1	EA
NO.	PARTS NO.	DESCRIPTION	Q'TY	U/M

LENGTH TOLERANCE IS $\pm 1.5\%$ OR $\pm 10$ MM, WHICHEVER IS GREATER.	STANDARD	REV A	UNIT CM(INCH)	<b>JYE BAO CO., LTD.</b> TAIPEI TAIWAN
	APPROVED		DATE	
	CHECKED		DATE	DESCRIPTION CABLE ASSEMBLY SMA JACK FOR BULKHEAD TO TNC PLUG
	DRAWING Albert		DATE	JYE BAO DRAWING NO. A85T30-223-XXX