

NO.	COMPONENTS	IMPEDANCE
1	SMA FEMALE FOR BULKHEAD	50 OHM
2	.085" TIN PLATED SEMI-RIGID CABLE (TIN PLATED RG405)	50 OHM
3	MMCX MALE RIGHT ANGLE	50 OHM

REVISION			
REV.	DESCRIPTION	DATE	APPROVED
-	INITIAL RELEASE	2012/08/15	

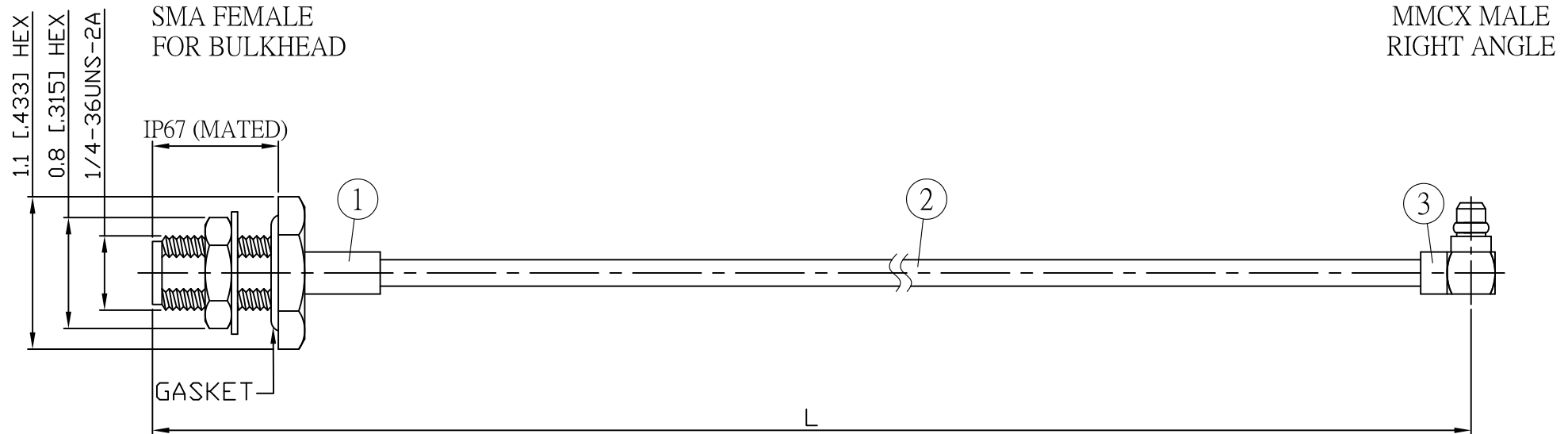

JYE BAO P/N	L CM (INCH)	L1 FT (MM)
A85E39-85T-15	15 (5.906)	0.474 (144.5)
A85E39-85T-30	30 (11.811)	0.966 (294.5)
A85E39-85T-50	50 (19.685)	1.622 (494.5)
A85E39-85T-100	100 (39.370)	3.263 (994.5)
A85E39-85T-150	150 (59.055)	4.903 (1494.5)
A85E39-85T-200	200 (78.740)	6.544 (1994.5)
A85E39-85T-XXX	CUSTOM LENGTH IN CM	- - -

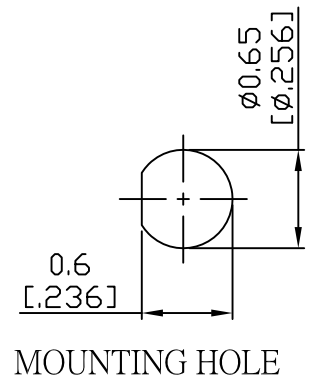

3	MMCX3300-9085	MMCX PLUG R/A	1	EA
2	.085TIN-W-P-50	CABLE	L1 (SEE TABLE)	FT
1	SMA8305-0085	SMA JACK	1	EA
NO.	PARTS NO.	DESCRIPTION	Q'TY	U/M

LENGTH TOLERANCE IS ±1.5% OR ±10MM, WHICHEVER IS GREATER.	STANDARD	REV -	UNIT CM(INCH)	JYE BAO CO., LTD. TAIPEI TAIWAN
	APPROVED	DATE		
	CHECKED	DATE		DESCRIPTION CABLE ASSEMBLY SMA JACK FOR BULKHEAD TO MMCX PLUG R/A
	DRAWING Albert	DATE		JYE BAO DRAWING NO. A85E39-85T-XXX