

NO.	COMPONENTS	IMPEDANCE
1	SMA FEMALE FOR BULKHEAD	50 OHM
2	.141" TIN PLATED SEMI-RIGID CABLE (TIN PLATED RG402)	50 OHM
3	BNC MALE RIGHT ANGLE	50 OHM

REVISION			
REV.	DESCRIPTION	DATE	APPROVED
-	INITIAL RELEASE	2011/03/15	
A	修正SMA螺紋規格	2013/10/01	

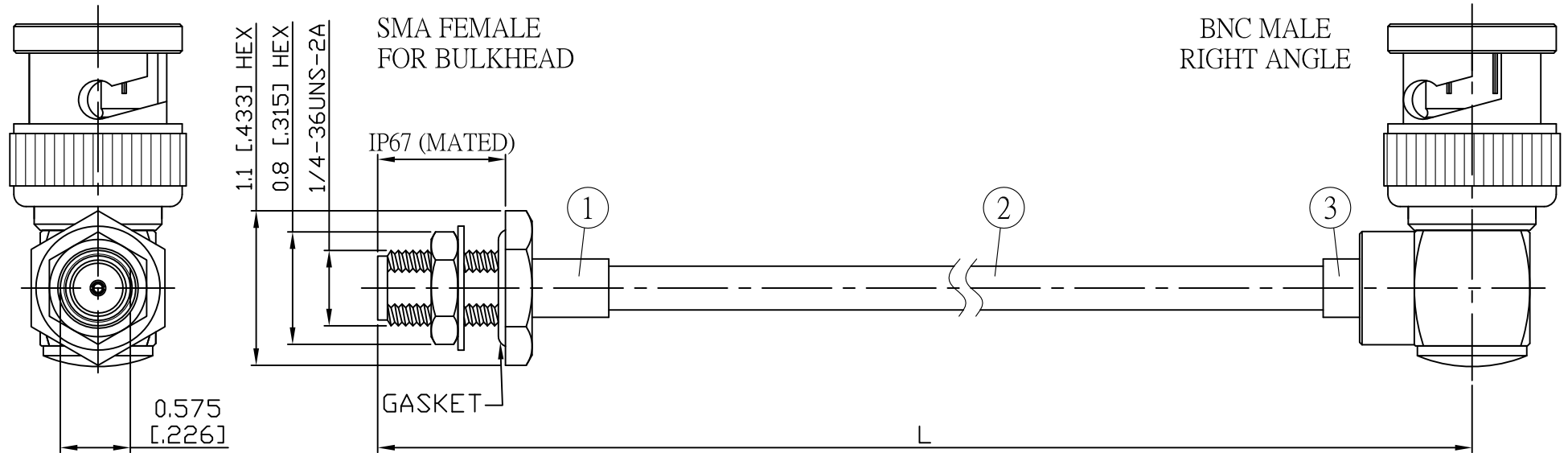

JYE BAO P/N	L CM (INCH)	L1 FT (MM)
A85B39-141T-15	15 (5.906)	0.476 (145.0)
A85B39-141T-30	30 (11.811)	0.968 (295.0)
A85B39-141T-50	50 (19.685)	1.624 (495.0)
A85B39-141T-100	100 (39.370)	3.264 (995.0)
A85B39-141T-150	150 (59.055)	4.905 (1495.0)
A85B39-141T-200	200 (78.740)	6.545 (1995.0)
A85B39-141T-XXX	CUSTOM LENGTH IN CM	- - -

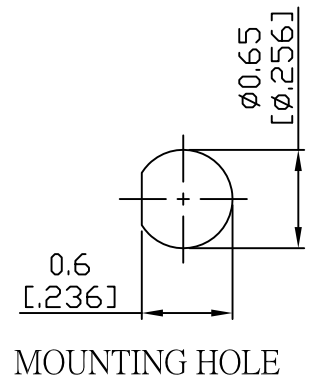

					STANDARD	REV A	UNIT CM(INCH)	JYE BAO CO., LTD.		
LENGTH TOLERANCE IS ±1.5% OR ±10MM, WHICHEVER IS GREATER.					APPROVED			TAIPEI TAIWAN		
					CHECKED			DESCRIPTION	CABLE ASSEMBLY SMA JACK FOR BULKHEAD TO BNC PLUG R/A	
					DRAWING	Albert		JYE BAO DRAWING NO.	A85B39-141T-XXX	
NO.	PARTS NO.	DESCRIPTION	Q'TY	U/M						